

UTC 2SA1837 PNP EPITAXIAL SILICON TRANSISTOR

POWER AMPLIFIER
APPLICATIONS DRIVER STAGE
AMPLIFIER APPLICATIONS

FEATURES

- * High Transition Frequency: $f_T=70\text{MHz}$ (Typ.)
- * Complementary to UTC 2SC4793

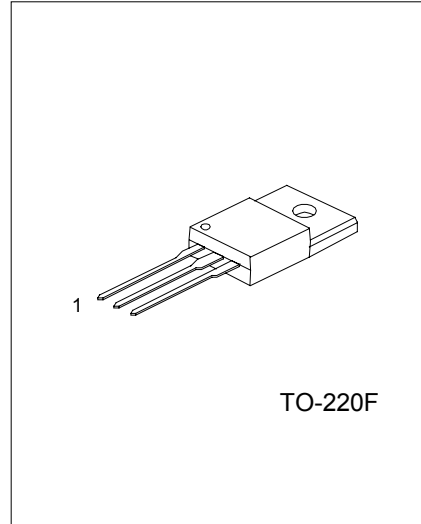

1: BASE 2: COLLECTOR 3: EMITTER

ABSOLUTE MAXIMUM RATINGS (Ta = 25°C)

PARAMETER	SYMBOL	RATINGS	UNIT
Collector-Base Voltage	V_{CBO}	-230	V
Collector-Emitter Voltage	V_{CEO}	-230	V
Emitter-Base Voltage	V_{EBO}	-5	V
Collector Current	I_C	-1	A
Base Current	I_B	-0.1	A
Collector Power Dissipation	P_C	2.0	W
Ta=25°C Tc=25°C		20	
Junction Temperature	T_J	150	°C
Storage Temperature Range	T_{stg}	-55 ~ 150	°C

ELECTRICAL CHARACTERISTICS (Ta=25°C)

PARAMETER	SYMBOL	TEST CONDITIONS	MIN	TYP	MAX	UNIT
Collector-Emitter Breakdown Voltage	$V_{(BR)CEO}$	$I_C = -10\text{mA}, I_B = 0$	-230			V
Collector Cut-off Current	I_{CBO}	$V_{CB} = -230\text{V}, I_E = 0$			-1.0	μA
Emitter Cut-off Current	I_{EBO}	$V_{EB} = -5\text{V}, I_C = 0$			-1.0	μA
DC Current Gain	h_{FE}	$V_{CE} = -5\text{V}, I_C = -100\text{mA}$	100		320	
Collector-Emitter Saturation Voltage	$V_{CE(sat)}$	$I_C = -500\text{mA}, I_B = -50\text{mA}$			-1.5	V
Base -Emitter Voltage	V_{BE}	$V_{CE} = -5\text{V}, I_C = -500\text{mA}$			-1.0	V
Transition Frequency	f_T	$V_{CE} = -10\text{V}, I_C = -100\text{mA}$		70		MHz
Collector Output Capacitance	C_{ob}	$V_{CB} = -10\text{V}, I_C = 0, f = 1\text{MHz}$		30		pF

UTC 2SA1837 PNP EPITAXIAL SILICON TRANSISTOR

TYPICAL CHARACTERISTICS

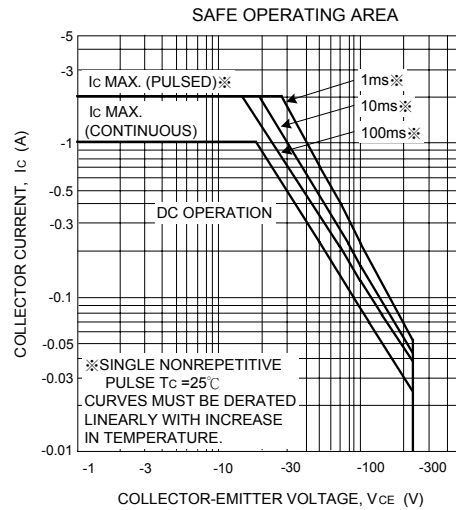
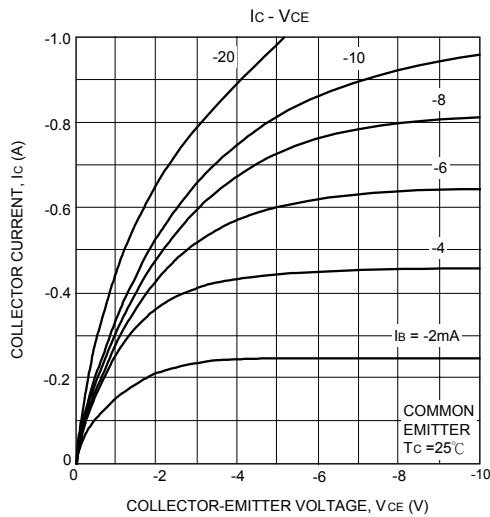
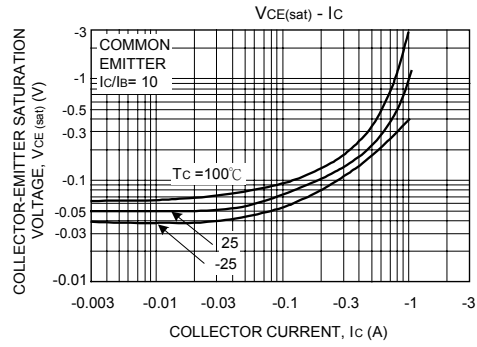
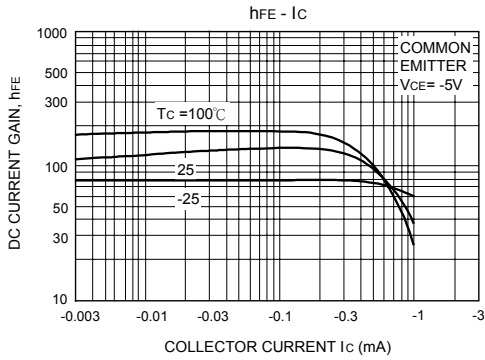
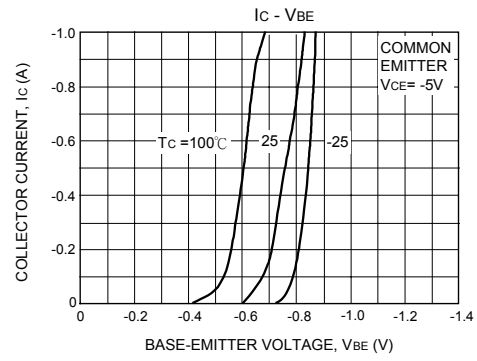
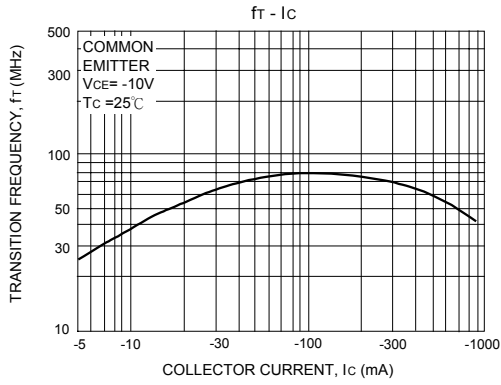

UTC 2SA1837 PNP EPITAXIAL SILICON TRANSISTOR

UTC assumes no responsibility for equipment failures that result from using products at values that exceed, even momentarily, rated values (such as maximum ratings, operating condition ranges, or other parameters) listed in products specifications of any and all UTC products described or contained herein. UTC products are not designed for use in life support appliances, devices or systems where malfunction of these products can be reasonably expected to result in personal injury. Reproduction in whole or in part is prohibited without the prior written consent of the copyright owner. The information presented in this document does not form part of any quotation or contract, is believed to be accurate and reliable and may be changed without notice.