



3308

LINEAR INTEGRATED CIRCUIT

SINGLE-SUPPLY DUAL HIGH CURRENT OPERATIONAL AMPLIFIER

DESCRIPTION

The UTC **3308** integrated circuit is a high gain, high output current, high output voltage swing dual operational amplifier capable of driving 150mA, specially for CD ROM, DVD devices.

FEATURES

- *Single Supply
- *Operating Voltage (+3V~+15V) ($\pm 1.5V \sim \pm 7.5V$)
- *High Output Current (150mA)
- *High Frequency Noise Rejection
- *Internal Enhanced Frequency Compensation

ORDERING INFORMATION

Ordering Number			Package	Packing
Normal	Lead Free Plating	Halogen Free		
3308-D08-T	3308L-D08-T	3308G-D08-T	DIP-8	Tube
3308-P08-R	3308L-P08-R	3308G-P08-R	TSSOP-8	Tape Reel
3308-S08-R	3308L-S08-R	3308G-S08-R	SOP-8	Tape Reel

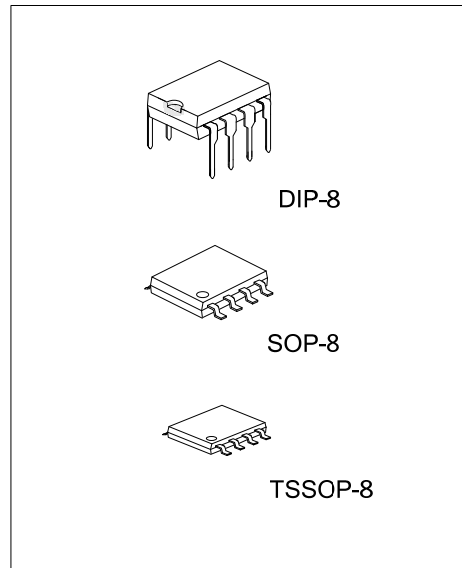

Lead-free: 3308L
 Halogen-free: 3308G

<p>3308L-D08-T</p> <p>(1) Packing Type</p> <p>(2) Package Type</p> <p>(3) Lead Plating</p>	<p>(1) T: Tube, R: Tape Reel</p> <p>(2) D08: DIP-8, P08: TSSOP-8, S08: SOP-8</p> <p>(3) G: Halogen Free, L: Lead Free, Blank: Pb/Sn</p>
--	---

■ PIN CONFIGURATIONS

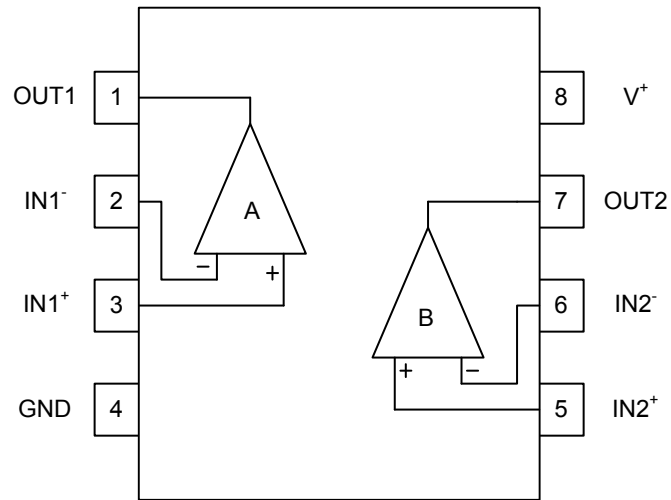

■ ABSOLUTE MAXIMUM RATINGS (Ta=25°C)

PARAMETER	SYMBOL	RATINGS	UNIT
Supply Voltage	V+	15V / ±7.5V	V
Differential Input Voltage	V _{I(DIFF)}	15	V
Input Voltage	V _{IN}	-0.3 ~ +15	V
Power Dissipation	P _D	300	mW
Junction Temperature	T _J	+125	°C
Operating Temperature	T _{OPR}	-20~+85	°C
Storage Temperature	T _{STG}	-40~+150	°C

Note: Absolute maximum ratings are those values beyond which the device could be permanently damaged. Absolute maximum ratings are stress ratings only and functional device operation is not implied.

■ ELECTRICAL CHARACTERISTICS (Ta=25°C, V⁺=5V)

PARAMETER	SYMBOL	TEST CONDITIONS	MIN	TYP	MAX	UNIT
Input Offset Voltage	V _{I(OFF)}	R _S =0Ω		2	5	mV
Input Offset Current	I _{I(OFF)}			5	100	nA
Input Bias Current	I _{I(BIAS)}			100	500	nA
Large Signal Voltage Gain	G _V	R _L =2KΩ	88	100		dB
Input Common Voltage Range	V _{I(COM)}		V ⁺ -2			V
Maximum Output Voltage Swing 1	V _{OM1}	R _L ≥2kΩ	3.5			V
Maximum Output Voltage Swing 2	V _{OM2}	I _O =70mA	3.2			V
Common Mode Rejection Ratio	CMR		80	90		dB
Supply Voltage Rejection Ratio	SVR		80	90		dB
Operating Current	I _{CC}	R _L = ∞	3	4	5	mA
Slew Rate	SR			1.0		V/μs
Unity Gain Bandwidth	GB			1.3		MHz
Operating Voltage Range	V ⁺				15	V

■ TYPICAL CHARACTERISTICS

Output Source Current vs. V_{SAT}^+

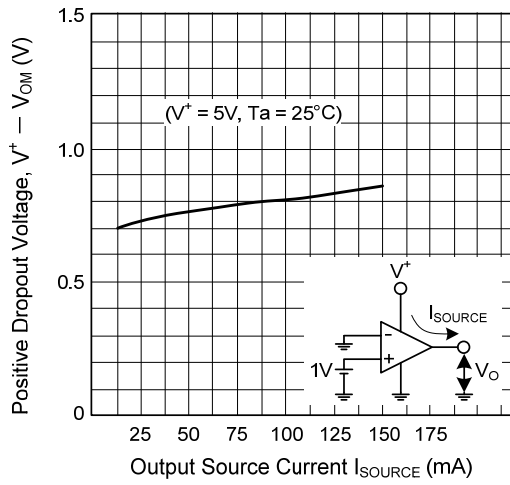

Output Sink Current vs. V_{SAT}

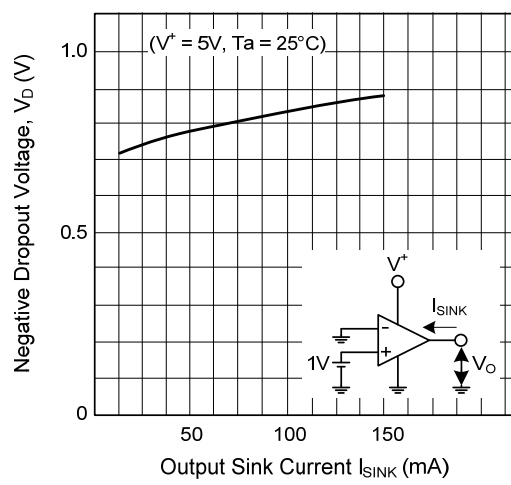

Input Offset Voltage vs. Temperature

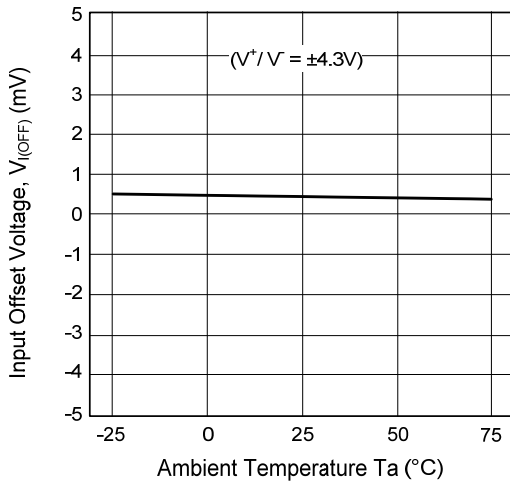

Input Bias Current vs. Temperature

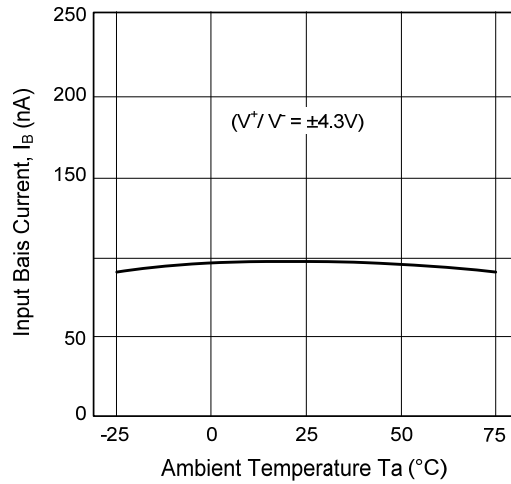

Operating Voltage vs. Operating Current

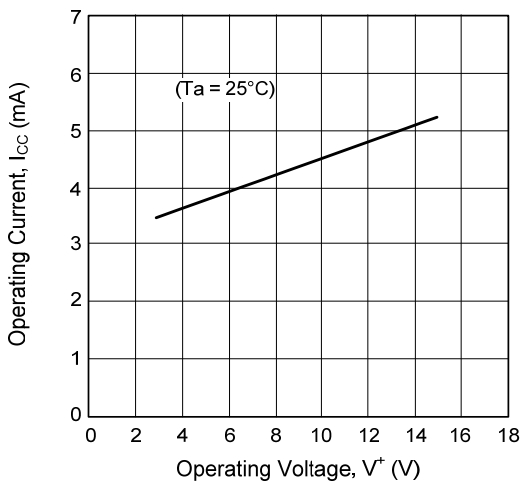

Maximum Output Voltage Swing 2 vs. Temperature

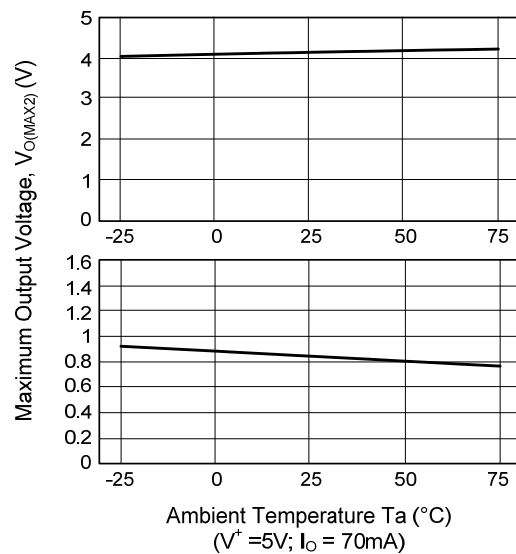

■ TYPICAL CHARACTERISTICS(Cont.)

Maximum Output Voltage vs. Operating Voltage

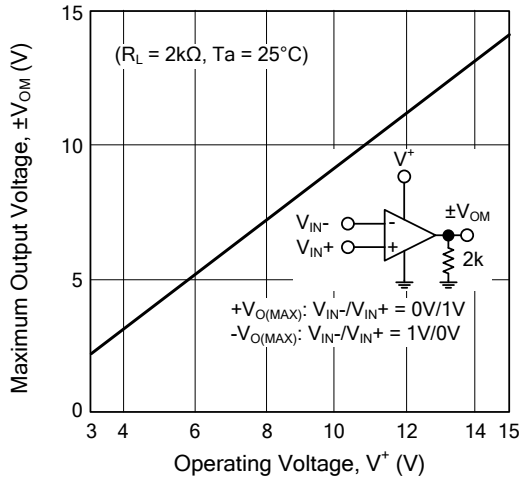

Maximum Output Voltage vs. Load Resistance

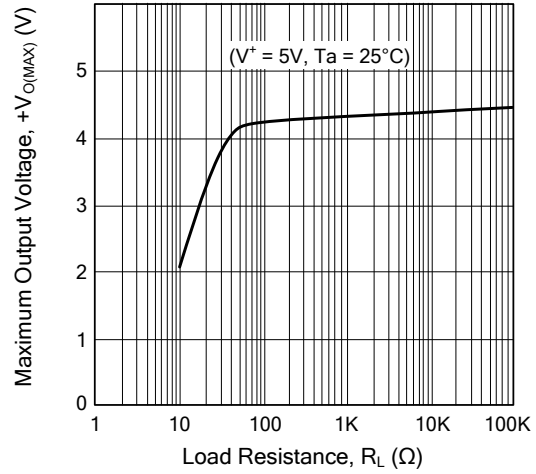

Maximum Output Voltage vs. Frequency

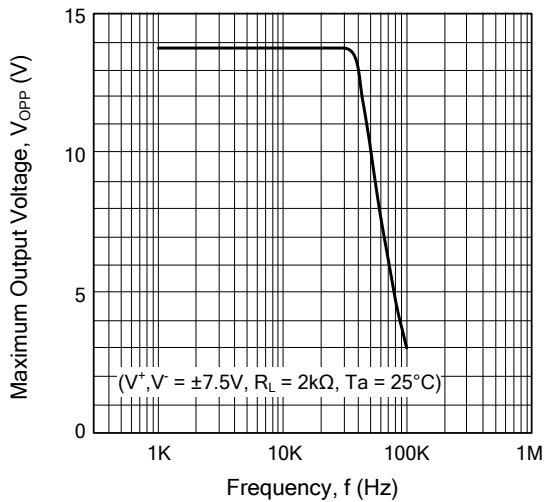

Voltage Gain, Phase vs. Frequency

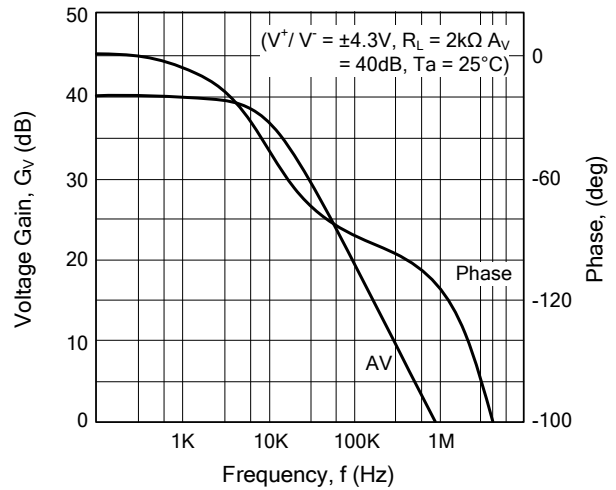

Operating Current vs. Temperature

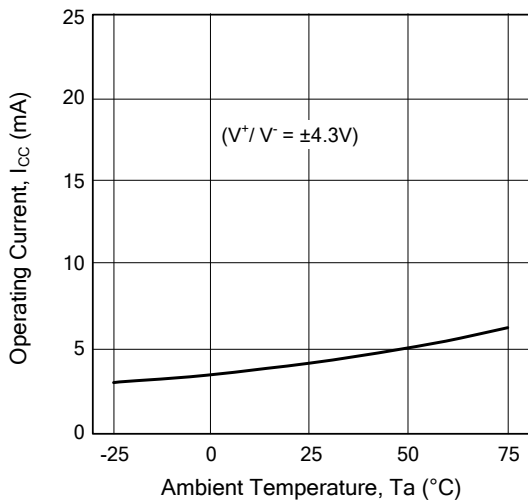

Maximum Output Voltage vs. Temperature

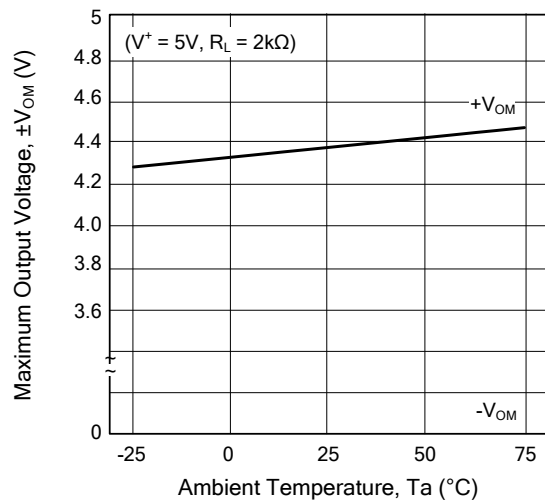

UTC assumes no responsibility for equipment failures that result from using products at values that exceed, even momentarily, rated values (such as maximum ratings, operating condition ranges, or other parameters) listed in products specifications of any and all UTC products described or contained herein. UTC products are not designed for use in life support appliances, devices or systems where malfunction of these products can be reasonably expected to result in personal injury. Reproduction in whole or in part is prohibited without the prior written consent of the copyright owner. The information presented in this document does not form part of any quotation or contract, is believed to be accurate and reliable and may be changed without notice.