

**PNP DIGITAL TRANSISTOR
(BUILT-IN RESISTORS)**

FEATURES

- * Built-in bias resistors enable the configuration of an inverter circuit without connecting external input resistors (see equivalent circuit).
- * The bias resistors consist of thin-film resistors with complete isolation to allow positive biasing of the input. They also have the advantage of almost completely eliminating parasitic effects.
- * Only the on/off conditions need to be set for operation, making device design easy.

EQUIVALENT CIRCUIT

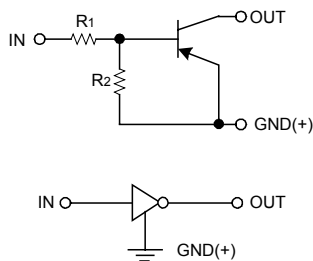

MARKING

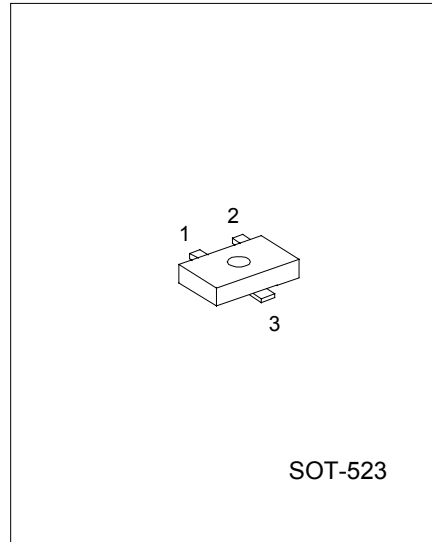
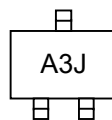

SOT-523

1: GND 2: IN 3: OUT

ABSOLUTE MAXIMUM RATINGS (Ta = 25°C)

PARAMETER	SYMBOL	RATINGS	UNIT
Supply voltage	V _{CC}	-50	V
Input voltage	V _{IN}	-12 ~ +5	V
Output current	I _O	-100	mA
	I _{C (Max.)}	-100	
Power Dissipation	P _D	150	mW
Junction temperature	T _J	150	°C
Storage temperature	T _{stg}	-55 ~ +150	°C

ELECTRICAL CHARACTERISTICS (Ta = 25°C)

PARAMETER	SYMBOL	TEST CONDITIONS	MIN	TYP	MAX	UNIT
Input voltage	V _{I (off)}	V _{CC} =-5V, I _O =-100 μA			-0.5	V
	V _{I (on)}	V _O =-0.3V, I _O =-5mA	-1.1			
Output voltage	V _{O (on)}	I _O /I _I =-5mA/-0.25mA		-0.1	-0.3	V
Input current	I _I	V _I =-5V			-3.6	mA
Output current	I _{O (off)}	V _{CC} =-50V, V _I =0V			-0.5	μA
DC current gain	G _I	V _O =-5V, I _O =-10mA	80			
Input resistance	R ₁		1.54	2.2	2.86	KΩ
Resistance ratio	R ₂ /R ₁		17	21	26	
Transition frequency	f _T	V _{CE} =-10V, I _E =5mA, f=100MHz *		250		MHz

* Transition frequency of the device

ELECTRICAL CHARACTERISTIC CURVES

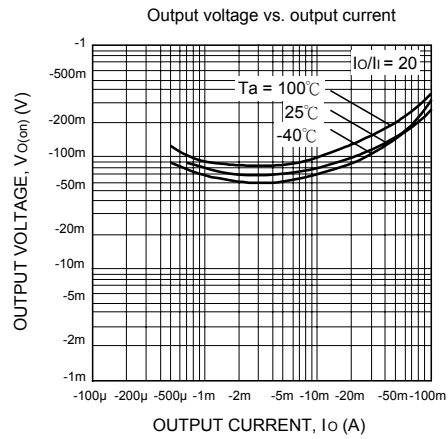
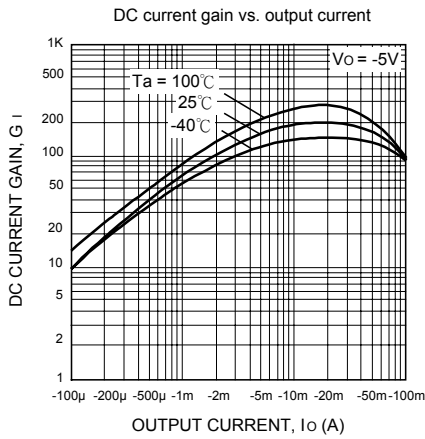
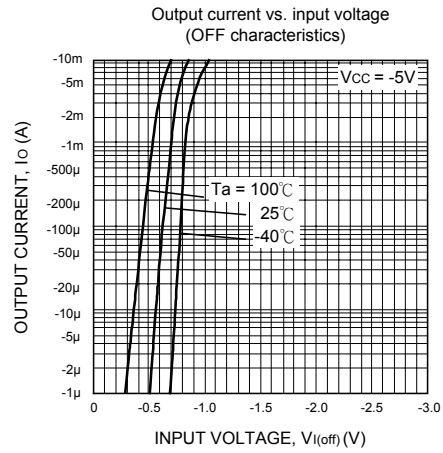
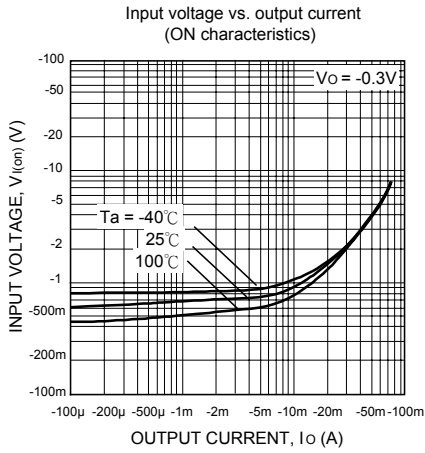

UTC assumes no responsibility for equipment failures that result from using products at values that exceed, even momentarily, rated values (such as maximum ratings, operating condition ranges, or other parameters) listed in products specifications of any and all UTC products described or contained herein. UTC products are not designed for use in life support appliances, devices or systems where malfunction of these products can be reasonably expected to result in personal injury. Reproduction in whole or in part is prohibited without the prior written consent of the copyright owner. The information presented in this document does not form part of any quotation or contract, is believed to be accurate and reliable and may be changed without notice.