



LR1101

CMOS IC

100mA, 4 μ A QUIESCENT CURRENT CMOS LDO REGULATOR

DESCRIPTION

The UTC **LR1101** series are ultra-low quiescent current CMOS LDO (Low Dropout Voltage). Designed for battery-powered system, the low 4 μ A quiescent current makes it an ideal choice. The Range of the output voltage is from 1.5V ~ 5V with 0.1V per step. And the max output current is 100mA.

Wide range of available output fits most of applications. Built-in output current-limiting provide maximal protection against any fault conditions.

FEATURES

- * 450mV typically dropout at 100mA
- * Ultra-low quiescent current: 4 μ A
- * Wide operating voltage ranges: 2V ~ 6V
- * Thermal current limiting protection
- * For stability only 1 μ F output capacitor is required
- * High power supply rejection ratio

ORDERING INFORMATION

Ordering Number		Package	Pin Assignment					Packing
Lead Free	Halogen Free		1	2	3	4	5	
LR1101L-xx-AB3-C-R	LR1101G-xx-AB3-C-R	SOT-89	G	I	O	-	-	Tape Reel
LR1101L-xx-AE3-5-R	LR1101G-xx-AE3-5-R	SOT-23	O	G	I	-	-	Tape Reel
LR1101L-xx-AF5-R	LR1101G-xx-AF5-R	SOT-25	I	G	\overline{EN}	NC	O	Tape Reel

Note: Pin Assignment: G: GND I: V_{IN} O: V_{OUT} NC: No Connection \overline{EN} : Enable

<p>LR1101G-xx-AB3-C-R</p> <p>(1) Packing Type (2) Pin Assignment (3) Package Type (4) Output Voltage Code (5) Green Package</p>	<p>(1) R: Tape Reel (2) refer to Pin Assignment (3) AB3: SOT-89, AE3: SOT-23, AF5: SOT-25 (4) xx: refer to Marking Information (5) G: Halogen Free and Lead Free, L: Lead Free</p>
---	--

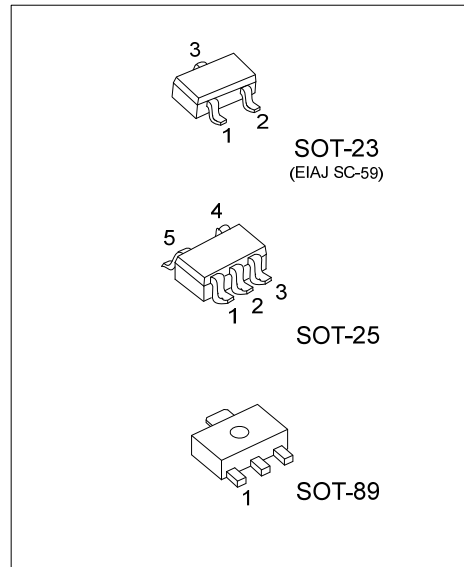

MARKING INFORMATIONS

PACKAGE	VOLTAGE CODE	PIN CODE	1	2	3	4	5	MARKING
SOT-89	15:1.5V 18:1.8V 25:2.5V 28:2.8V 30:3.0V 33:3.3V 35:3.5V 36:3.6V 47:4.7V 50:5.0V	C	G	I	O	-	-	
SOT-25		-	I	G	$\overline{\text{EN}}$	NC	O	
SOT-23		5	O	G	I	-	-	

PIN DESCRIPTION

PIN NO.			PIN NAME	DESCRIPTION
SOT-89	SOT-25	SOT-23		
1	2	2	GND	Ground
2	1	3	V_{IN}	Input voltage
3	5	1	V_{OUT}	Output voltage
-	3	-	$\overline{\text{EN}}$	Chip enable input
-	4	-	NC	No connection

BLOCK DIAGRAM

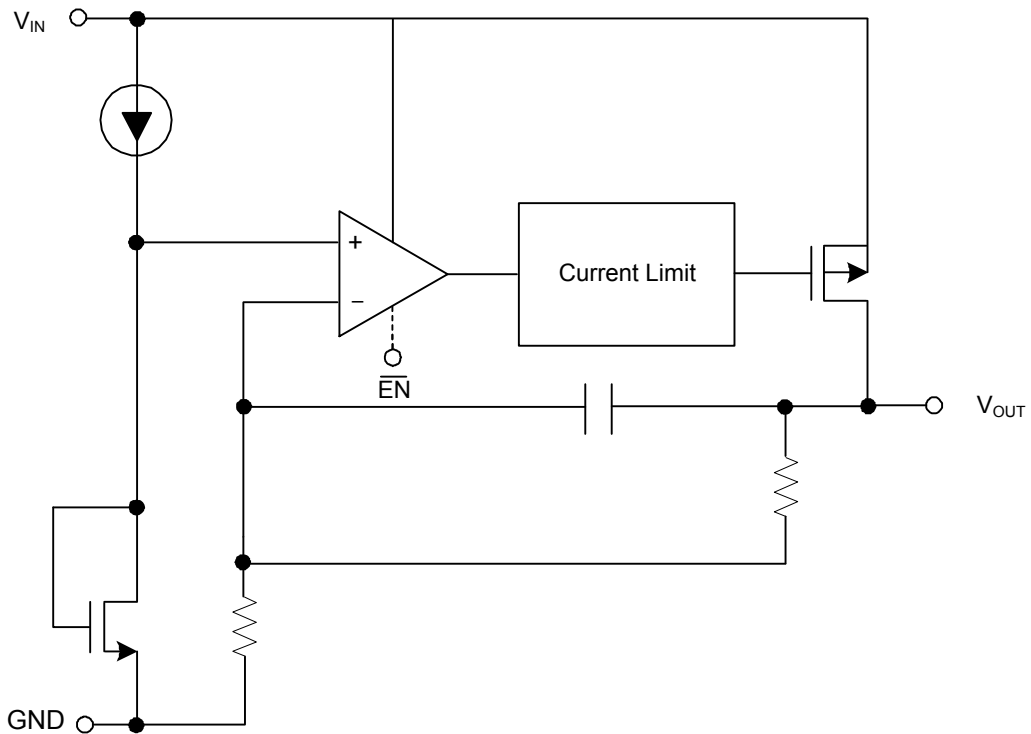

■ ABSOLUTE MAXIMUM RATINGS

PARAMETER	SYMBOL	RATINGS	UNIT
Input Voltage	V_{IN}	7	V
Power Dissipation ($T_A = 25^\circ\text{C}$)	SOT-89	500	mW
	SOT-23	250	mW
	SOT-25	250	mW
Junction Temperature	T_J	+125	$^\circ\text{C}$
Operating Temperature	T_{OPR}	-40 ~ +85	$^\circ\text{C}$
Storage Temperature	T_{STG}	-65 ~ +150	$^\circ\text{C}$

Note: Absolute maximum ratings are those values beyond which the device could be permanently damaged. Absolute maximum ratings are stress ratings only and functional device operation is not implied.

■ THERMAL DATA

PARAMETER	SYMBOL	RATINGS	UNIT
Thermal Resistance	SOT-89	180	$^\circ\text{C}/\text{W}$
	SOT-23	250	$^\circ\text{C}/\text{W}$
	SOT-25	250	$^\circ\text{C}/\text{W}$

■ ELECTRICAL CHARACTERISTICS ($V_{IN}=5.5\text{V}$, $C_I=1\mu\text{F}$, $C_O=1\mu\text{F}$, $T_A=25^\circ\text{C}$, unless otherwise specified)

PARAMETER	SYMBOL	TEST CONDITIONS	MIN.	TYP.	MAX.	UNIT
Input Voltage Range	V_{IN}		2		6	V
Output Voltage Accuracy	ΔV_{OUT}	$I_L = 1\text{mA}$	-2		+2	%
Line Regulation	ΔV_{LINE}	$V_{IN} = (V_{OUT} + 0.3\text{V})$ to 6V, $V_{IN} \geq 3.6\text{V}$, $I_{OUT} = 1\text{mA}$	-0.2		0.2	%/V
Load Regulation	ΔV_{LOAD}	$I_{OUT} = 0\text{mA}$ to 100mA		0.01	0.04	%/mA
Maximum Output Current	I_{MAX}	$V_{IN} = V_{OUT} + 0.6\text{V}$, $V_{IN} \geq 3.6\text{V}$	100			mA
Current Limit	I_{LIMIT}	$I_L = 100\text{mA}$	150	250		mA
GND Pin Current	I_G	No Load		4	7	μA
		$I_{OUT} = 100\text{mA}$		4	10	
Dropout Voltage	V_D	$I_{OUT} = 1\text{mA}$, $V_{IN} \geq 3.6\text{V}$		4	10	mV
		$I_{OUT} = 50\text{mA}$, $V_{IN} \geq 3.6\text{V}$		200	300	
		$I_{OUT} = 100\text{mA}$, $V_{IN} \geq 3.6\text{V}$		450	600	
Stand By Current	I_{STN-BY}	$\overline{EN} = V_{IN}$		0.1	1	μA
\overline{EN} Threshold	\overline{EN}	$V_{OUT} = \text{High}$	0		0.6	V
		$V_{OUT} = \text{Low}$	2		V_{IN}	
Short Current	I_{SC}	$V_{OUT} = 0$			650	mA
Thermal Shutdown		Exterior Calefaction	125			$^\circ\text{C}$

■ APPLICATION INFORMATION

Between V_{OUT} and GND a $1\mu\text{F}$ (or larger) capacitor is recommended for stability. Without the capacitor the part may oscillate. When operating below -25°C any type of capacitor can be used, but not Aluminum electrolytes. If there's no limit the capacitance may be increased.

Between V_{IN} to GND a $1\mu\text{F}$ capacitor (or larger) should be placed.

■ APPLICATION CIRCUIT

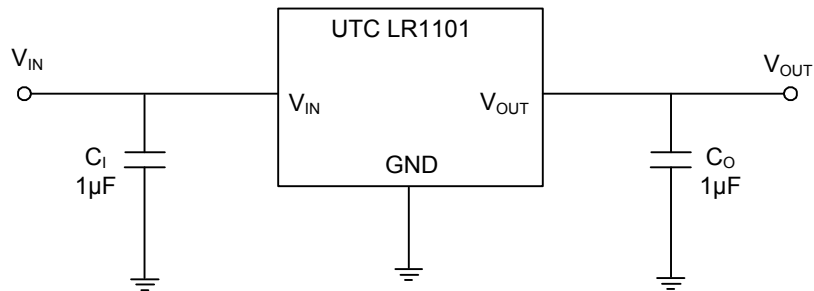

TYPICAL CHARACTERISTICS

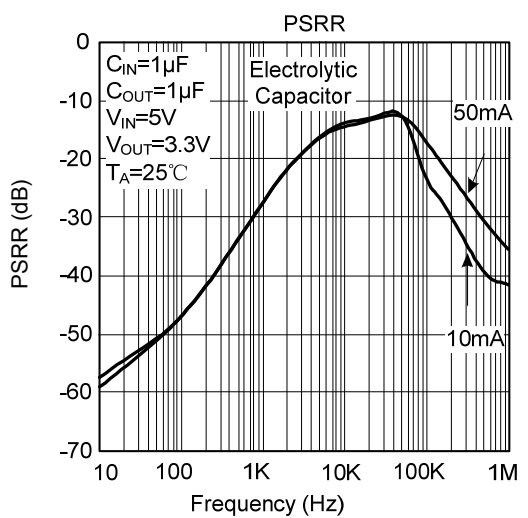
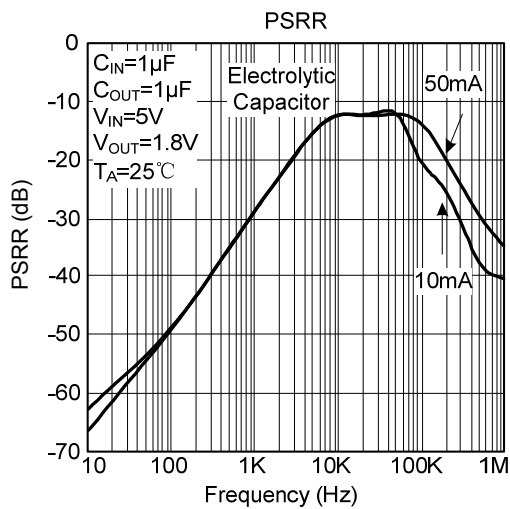
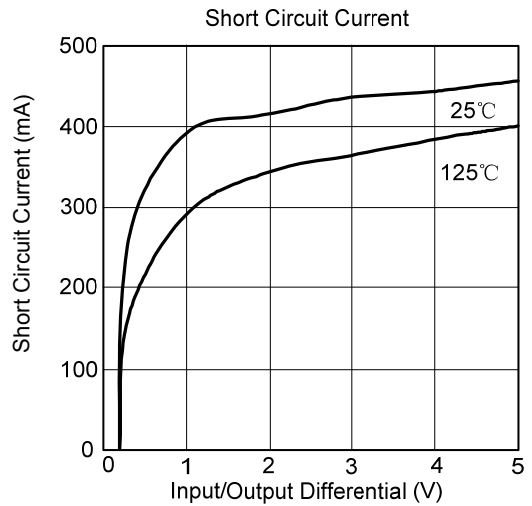
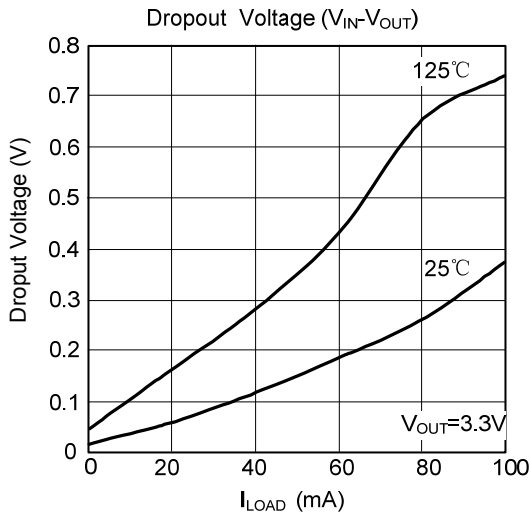
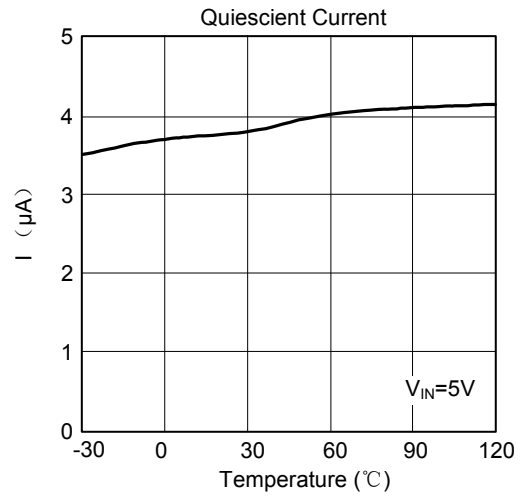
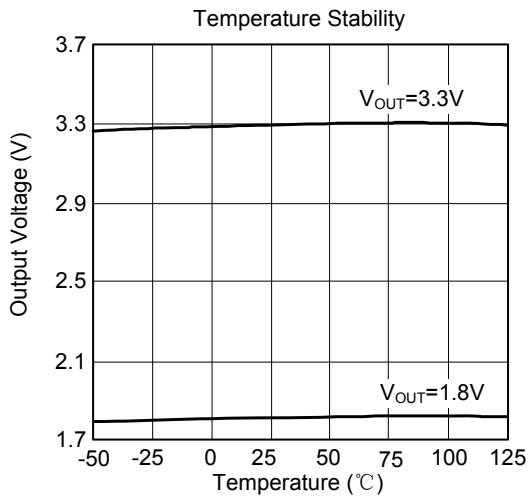

■ TYPICAL CHARACTERISTICS (Cont.)

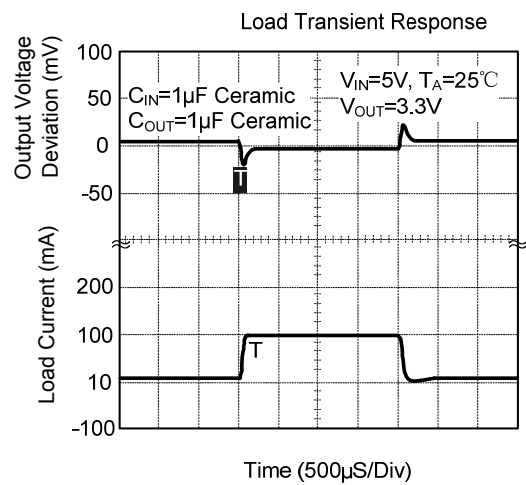
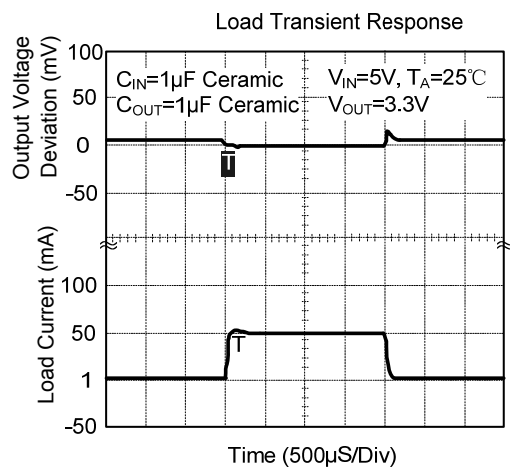
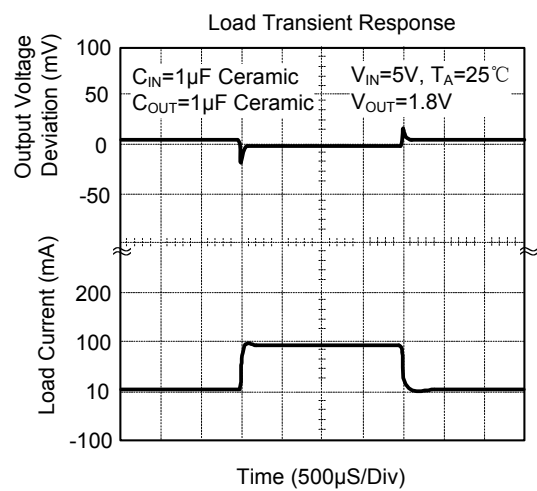
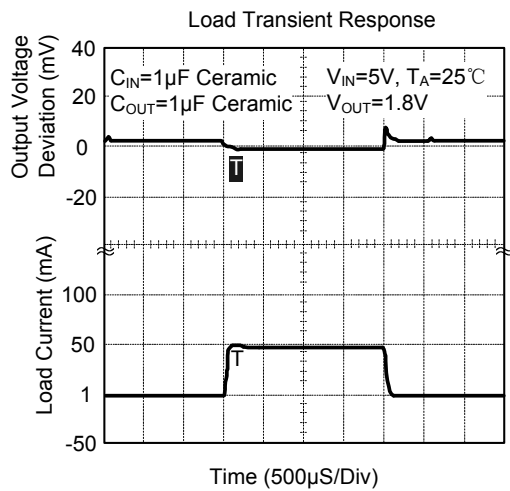
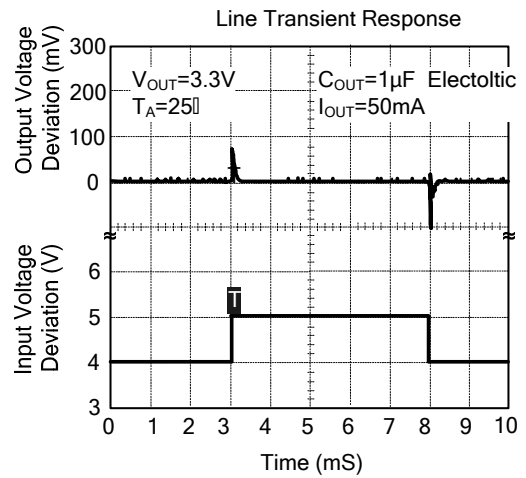
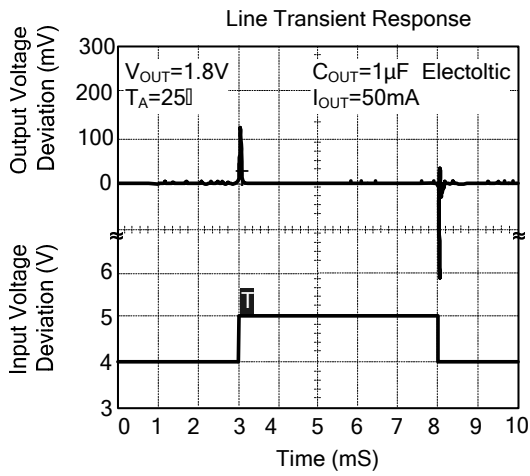

UTC assumes no responsibility for equipment failures that result from using products at values that exceed, even momentarily, rated values (such as maximum ratings, operating condition ranges, or other parameters) listed in products specifications of any and all UTC products described or contained herein. UTC products are not designed for use in life support appliances, devices or systems where malfunction of these products can be reasonably expected to result in personal injury. Reproduction in whole or in part is prohibited without the prior written consent of the copyright owner. UTC reserves the right to make changes to information published in this document, including without limitation specifications and product descriptions, at any time and without notice. This document supersedes and replaces all information supplied prior to the publication hereof.