

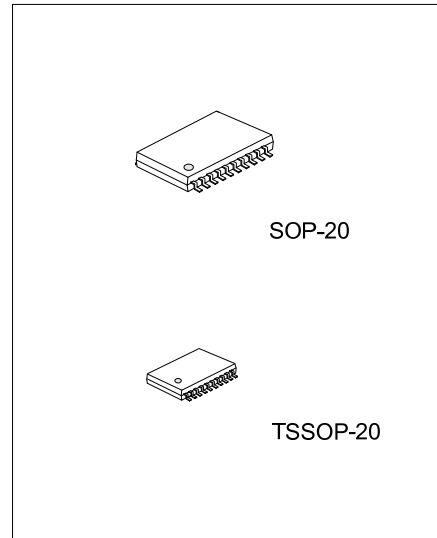

U74HC541

CMOS IC

OCTAL BUFFERS AND LINE DRIVERS WITH 3-STATE OUTPUTS



DESCRIPTION

The **U74HC541** is a octal buffers and line drivers with 3-state outputs and 8 channels.

FEATURES

- * Operate from 2V to 6V
- * Max t_{PD} of 23ns at 4.5 V($C_L=50pF$)
- * Typical $V_{IH} < 3.15V$ at $V_{CC}=4.5V, T_a=25^\circ C$
- * Typical $V_{IL} > 1.35V$ at $V_{CC}=4.5V, T_a=25^\circ C$

ORDERING INFORMATION

Ordering Number		Package	Packing
Lead Free	Halogen Free		
U74HC541L-S20-R	U74HC541G-S20-R	SOP-20	Tape Reel
U74HC541L-P20-R	U74HC541G-P20-R	TSSOP-20	Tape Reel

<p>U74HC541G-S20-R</p> <p>(1) Packing Type</p> <p>(2) Package Type</p> <p>(3) Green Package</p>	<p>(1) R: Tape Reel</p> <p>(2) R20: SSOP-20, P20: TSSOP-20</p> <p>(3) G: Halogen Free and Lead Free</p>
---	---

MARKING

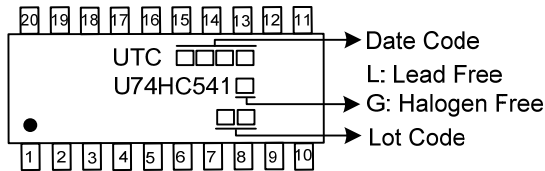

■ PIN CONFIGURATION

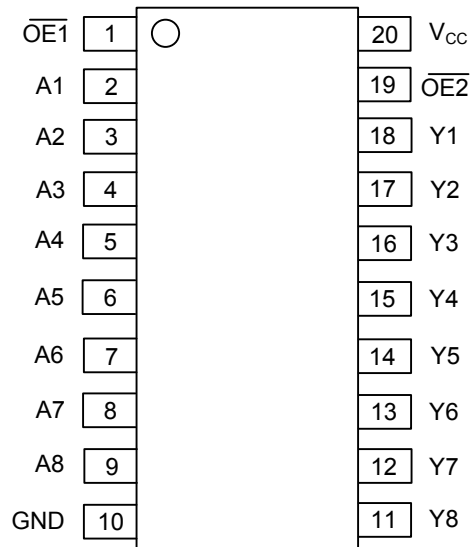

■ FUNCTION TABLE

INPUTS $\overline{OE1}$	INPUTS $\overline{OE2}$	INPUTS(A)	OUTPUT(Y)
L	L	L	L
L	L	H	H
H	X	X	Z
X	H	X	Z

Note: H: HIGH voltage level L: LOW voltage level Z: High impedance X: Don't care

■ LOGIC SYMBOL

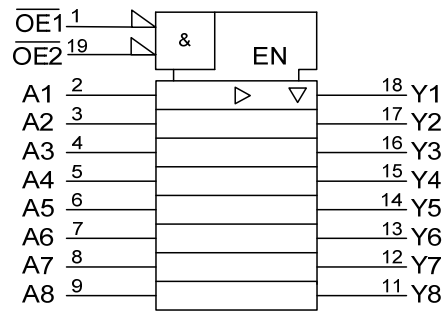

■ LOGIC DIAGRAM

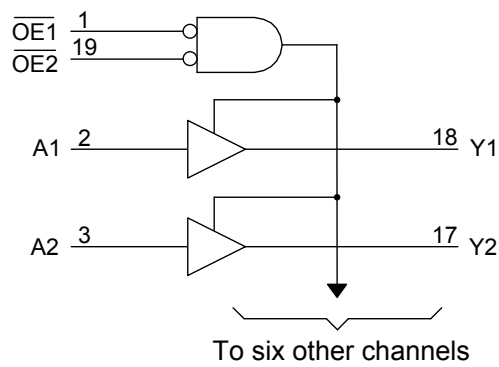

■ ABSOLUTE MAXIMUM RATING

PARAMETER	SYMBOL	RATINGS	UNIT
Supply Voltage	V_{CC}	-0.5 ~ 7	V
V_{CC} or GND Current	I_{CC}	± 70	mA
Output Current	I_{OUT}	± 35	mA
Input Clamp Current	I_{IK}	± 20	mA
Output Clamp Current	I_{OK}	± 20	mA
Storage Temperature	T_{STG}	-65 ~ + 150	$^{\circ}C$

Note: Absolute maximum ratings are those values beyond which the device could be permanently damaged.
 Absolute maximum ratings are stress ratings only and functional device operation is not implied.

■ RECOMMENDED OPERATING CONDITIONS

PARAMETER	SYMBOL	TEST CONDITIONS	MIN	TYP	MAX	UNIT
Supply Voltage	V_{CC}		2		6	V
High-Level Input Voltage	V_{IH}	$V_{CC}=2V$	1.5			V
		$V_{CC}=4.5V$	3.15			
		$V_{CC}=6V$	4.2			
Low-Level Input Voltage	V_{IL}	$V_{CC}=2V$			0.5	V
		$V_{CC}=4.5V$			1.35	
		$V_{CC}=6V$			1.8	
Input Voltage	V_{IN}		0		V_{CC}	V
Output Voltage	V_{OUT}		0		V_{CC}	V
Input Transition Rise or Fall Rate	t_r, t_f	$V_{CC}=2V$			1000	ns
		$V_{CC}=4.5V$			500	
		$V_{CC}=6V$			400	
Operating Temperature	T_A		-40		+125	$^{\circ}C$

■ ELECTRICAL CHARACTERISTICS ($T_A=25^{\circ}C$)

PARAMETER	SYMBOL	TEST CONDITIONS	MIN	TYP	MAX	UNIT
Output Voltage High-Level	V_{OH}	$V_{CC}=2V, I_{OH}=-20\mu A$	1.9	1.998		V
		$V_{CC}=4.5V, I_{OH}=-20\mu A$	4.4	4.499		
		$V_{CC}=6V, I_{OH}=-20\mu A$	5.9	5.999		
		$V_{CC}=4.5V, I_{OH}=-6mA$	3.98	4.3		
		$V_{CC}=6V, I_{OH}=-7.8mA$	5.48	5.8		
Output Voltage Low-Level	V_{OL}	$V_{CC}=2V, I_{OL}=20\mu A$		0.002	0.1	V
		$V_{CC}=4.5V, I_{OL}=20\mu A$		0.001	0.1	
		$V_{CC}=6V, I_{OL}=20\mu A$		0.001	0.1	
		$V_{CC}=4.5V, I_{OL}=6mA$		0.17	0.26	
		$V_{CC}=6V, I_{OL}=7.8mA$		0.15	0.26	
Input Leakage Current	$I_{I(LEAK)}$	$V_{CC}=6V, V_{IN}=V_{CC}$ or GND		± 0.1	± 100	nA
Output Off-state Current	I_{OZ}	$V_{CC}=6V, V_{OUT}=V_{CC}$ or GND		± 0.01	± 0.5	μA
Quiescent Supply Current	I_Q	$V_{CC}=6V, V_{IN}=V_{CC}$ or GND, $I_{OUT}=0$			8	μA
Input Capacitance	C_{IN}	$V_{CC}=2V$ to 6V		3	10	pF

■ SWITCHING CHARACTERISTICS (T_A=25°C, C_L=50pF)

PARAMETER	SYMBOL	TEST CONDITIONS	MIN	TYP	MAX	UNIT
Propagation Delay From Input (A) to Output (Y)	t _{PLH} /t _{PHL}	V _{CC} =2V		40	115	ns
		V _{CC} =4.5V		12	23	
		V _{CC} =6V		10	20	
Output Enable Time From \overline{OE} to Y	t _{PZL} /t _{PZH}	V _{CC} =2V		80	150	ns
		V _{CC} =4.5V		17	30	
		V _{CC} =6V		15	26	
Output Disable Time From \overline{OE} to Y	t _{PLZ} /t _{PHZ}	V _{CC} =2V		40	150	ns
		V _{CC} =4.5V		18	30	
		V _{CC} =6V		17	26	
Output Y	t _t	V _{CC} =2V		28	60	ns
		V _{CC} =4.5V		8	12	
		V _{CC} =6V		6	10	

■ SWITCHING CHARACTERISTICS (T_A=25°C, C_L=150pF)

PARAMETER	SYMBOL	TEST CONDITIONS	MIN	TYP	MAX	UNIT
Propagation Delay From Input (A) to Output (Y)	t _{PLH} /t _{PHL}	V _{CC} =2V		65	165	ns
		V _{CC} =4.5V		16	33	
		V _{CC} =6V		14	28	
Output Enable Time From \overline{OE} to Y	t _{PZL} /t _{PZH}	V _{CC} =2V		100	200	ns
		V _{CC} =4.5V		20	40	
		V _{CC} =6V		17	34	
Output Y	t _t	V _{CC} =2V		45	210	ns
		V _{CC} =4.5V		17	42	
		V _{CC} =6V		13	36	

■ OPERATING CHARACTERISTICS (T_A=25°C)

PARAMETER	SYMBOL	TEST CONDITIONS	MIN	TYP	MAX	UNIT
Power Dissipation Capacitance	C _{PD}	No Load		35		pF

■ TEST CIRCUIT AND WAVEFORMS

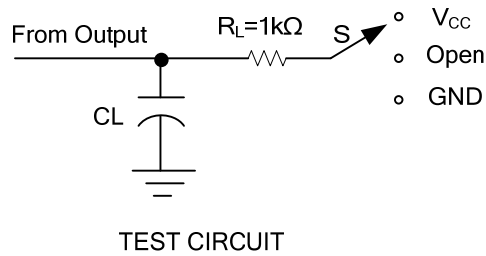

TEST	S
t_{PLH}/t_{PHL}	Open
t_{PHZ}/t_{PZH}	GND
t_{PLZ}/t_{PZL}	V_{CC}

Parameter	R_L	C_L
t_{en}	1K Ω	50 pF or 150 pF
		50 pF or 150 pF
t_{dis}	1K Ω	50 pF
		50 pF
t_{PD} or t_t	—	50 pF or 150 pF

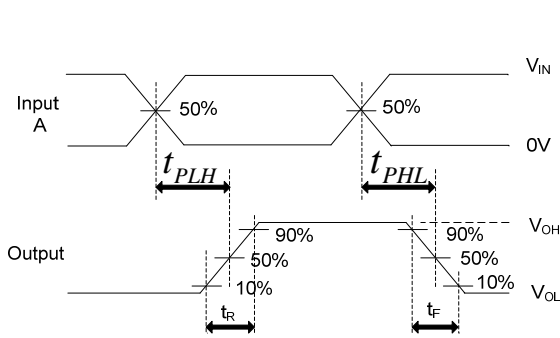

PROPAGATION DELAY TIMES

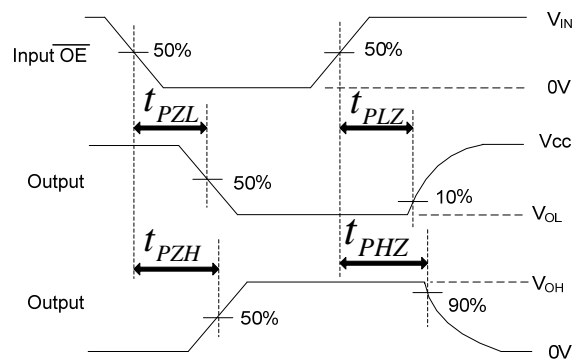

ENABLE AND DISABLE TIMES

Note: C_L includes probe and jig capacitance.

All input pulses are supplied by generators having the following characteristics: PRR \leq 1MHz, $Z_o = 50\Omega$, $t_r=6ns$, $t_f=6ns$.

UTC assumes no responsibility for equipment failures that result from using products at values that exceed, even momentarily, rated values (such as maximum ratings, operating condition ranges, or other parameters) listed in products specifications of any and all UTC products described or contained herein. UTC products are not designed for use in life support appliances, devices or systems where malfunction of these products can be reasonably expected to result in personal injury. Reproduction in whole or in part is prohibited without the prior written consent of the copyright owner. UTC reserves the right to make changes to information published in this document, including without limitation specifications and product descriptions, at any time and without notice. This document supersedes and replaces all information supplied prior to the publication hereof.