



PUMX1

DUAL TRANSISTOR

NPN GENERAL PURPOSE DUAL TRANSISTOR

DESCRIPTION

Two independently operating NPN transistors.

FEATURES

- * Low current (max.100mA)
- * Low voltage (max.40V)
- * Reduces number of components and board space.
- * Complement to PUMT1.

APPLICATIONS

- * General purpose switching and amplification.

SYMBOL

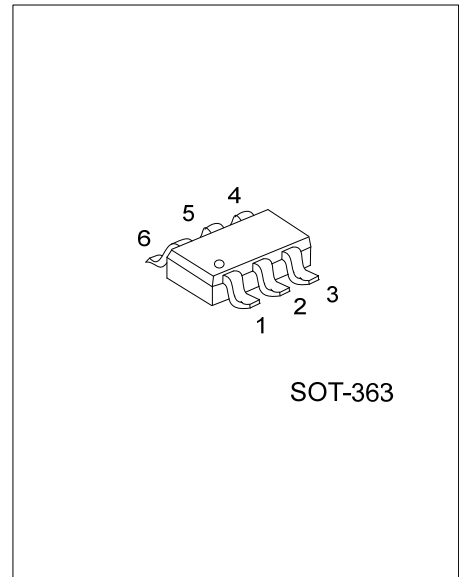
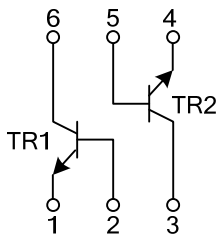

ORDERING INFORMATION

Ordering Number		Package	Pin Assignment						Packing
Lead Free	Halogen-Free		1	2	3	4	5	6	
PUMX1L-AL6-R	PUMX1G-AL6-R	SOT-363	E1	B1	C2	E2	B2	C1	Tape Reel

Note: Pin Assignment: E: Emitter B: Base C: Collector

<p>PUMX1G-AL6-R</p> <p>(1) Packing Type</p> <p>(2) Package Type</p> <p>(3) Green Package</p>	<p>(1) R: Tape Reel</p> <p>(2) AL6: SOT-363</p> <p>(3) G: Halogen Free and Lead Free, L: Lead Free</p>
--	--

MARKING

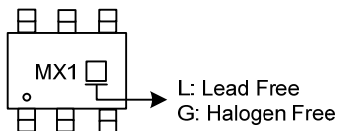

■ ABSOLUTE MAXIMUM RATINGS ($T_A=25^\circ\text{C}$, unless otherwise specified)

PARAMETER	SYMBOL	RATINGS	UNIT
Collector-Base Voltage	V_{CBO}	50	V
Collector-Emitter Voltage	V_{CEO}	40	V
Emitter-Base Voltage	V_{EBO}	5	V
Collector Current (DC)	I_C	100	mA
Peak Collector Current	I_{CM}	200	mA
Peak Base Current	I_{BM}	200	mA
Collector Power Dissipation	P_C	200	mW
Junction Temperature	T_J	+150	$^\circ\text{C}$
Storage Temperature	T_{STG}	-55 ~ +150	$^\circ\text{C}$

Note: Absolute maximum ratings are those values beyond which the device could be permanently damaged. Absolute maximum ratings are stress ratings only and functional device operation is not implied.

■ ELECTRICAL CHARACTERISTICS ($T_A=25^\circ\text{C}$, unless otherwise specified)

PARAMETER	SYMBOL	TEST CONDITIONS	MIN	TYP	MAX	UNIT
Collector-Emitter Saturation Voltage (Note)	$V_{CE(SAT)}$	$I_C=50\text{mA}$, $I_B=5\text{mA}$			200	mV
Collector Cutoff Current	I_{CBO}	$I_E=0$, $V_{CB}=30\text{V}$			100	nA
Emitter Cutoff Current	I_{EBO}	$V_{EB}=4\text{V}$, $I_C=0$			100	nA
DC Current Transfer Ratio	h_{FE}	$I_C=1\text{mA}$, $V_{CE}=6\text{V}$	120			
Transition Frequency	f_T	$I_C=2\text{mA}$, $V_{CE}=12\text{V}$, $f=100\text{MHz}$	100			MHz
Collector capacitance	C_C	$I_E=I_C=0$, $V_{CB}=12\text{V}$, $f=1\text{MHz}$			1.5	pF

Note: Pulse test: $t_p \leq 300\mu\text{s}$, $\delta \leq 0.02$.

■ TYPICAL CHARACTERISTICS

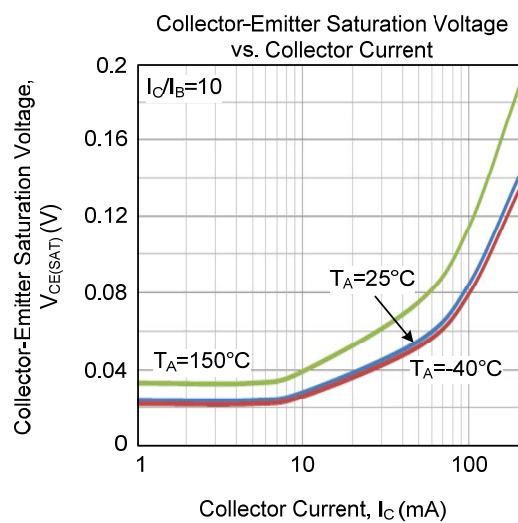
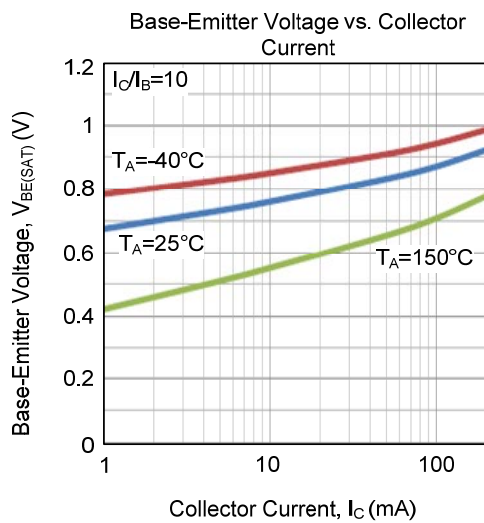
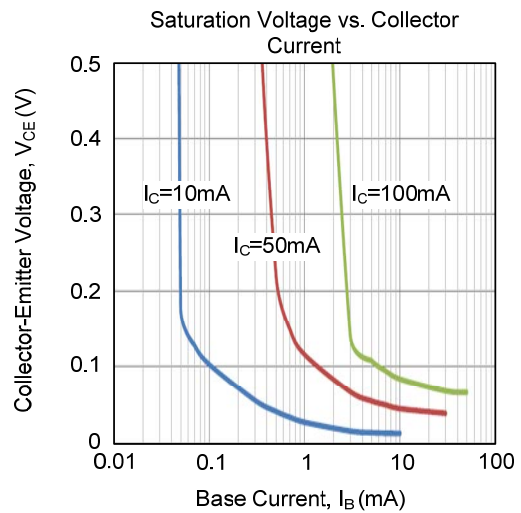
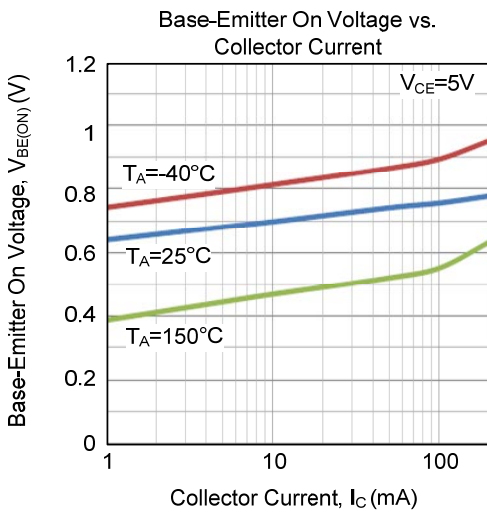
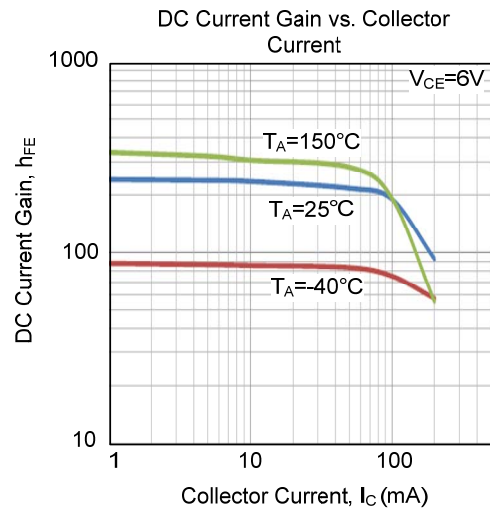
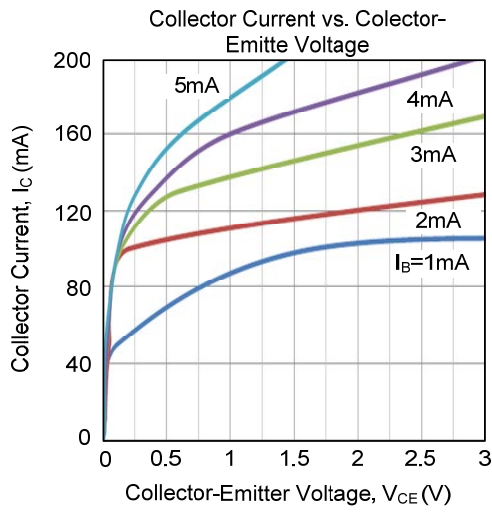

■ TYPICAL CHARACTERISTICS

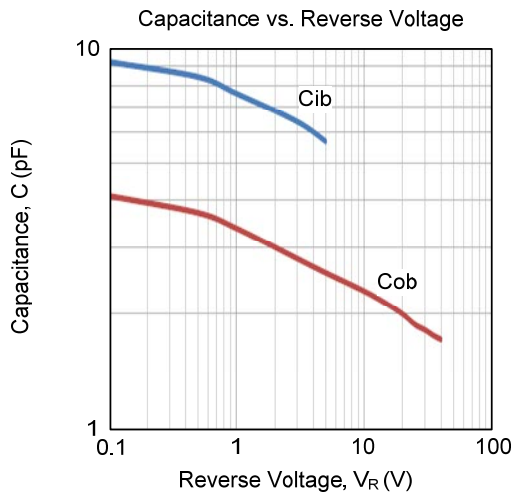

UTC assumes no responsibility for equipment failures that result from using products at values that exceed, even momentarily, rated values (such as maximum ratings, operating condition ranges, or other parameters) listed in products specifications of any and all UTC products described or contained herein. UTC products are not designed for use in life support appliances, devices or systems where malfunction of these products can be reasonably expected to result in personal injury. Reproduction in whole or in part is prohibited without the prior written consent of the copyright owner. UTC reserves the right to make changes to information published in this document, including without limitation specifications and product descriptions, at any time and without notice. This document supersedes and replaces all information supplied prior to the publication hereof.