



U74AHC1G14

CMOS IC

SINGLE SCHMITT-TRIGGER INVERTER GATE

DESCRIPTION

The **U74AHC1G14** contains one inverter with Schmitt-trigger, which provides the Function $Y = \overline{A}$.

They provide an inverting buffer function with Schmitt trigger action. These devices are capable of transforming slowly changing input signals into sharply defined, jitter-free output signals.

FEATURES

- * Operation Voltage Range: 2V ~ 5.5V
- * Low power consumption, $I_{CC} = 1\mu A$ (Max) at 5.5V
- * $\pm 8mA$ output driver at 5V

ORDERING INFORMATION

Ordering Number		Package	Packing
Lead Free	Halogen Free		
U74AHC1G14L-AE5-R	U74AHC1G14G-AE5-R	SOT-23-5	Tape Reel
U74AHC1G14L-AF5-R	U74AHC1G14G-AF5-R	SOT-25	Tape Reel
U74AHC1G14L-AL5-R	U74AHC1G14G-AL5-R	SOT-353	Tape Reel

<p>U74AHC1G14G-AE5-R</p> <p>(1) Packing Type (2) Package Type (3) Green Package</p>	<p>(1) R: Tape Reel (2) AE5: SOT-23-5, AF5: SOT-25, AL5: SOT-353 (3) G: Halogen Free and Lead Free, L: Lead Free</p>
---	--

MARKING

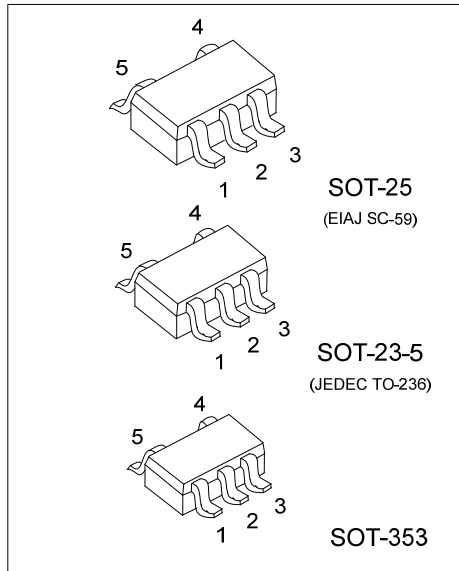
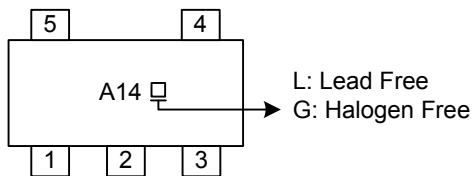

■ PIN CONFIGURATION

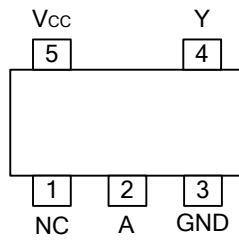

■ FUNCTION TABLE

INPUT(A)	OUTPUT(Y)
L	H
H	L

Note: H: high voltage level; L: low voltage level

■ LOGIC DIAGRAM

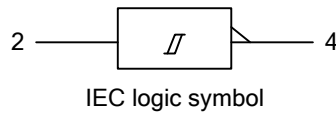
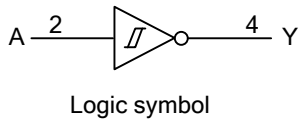

■ ABSOLUTE MAXIMUM RATING (T_A=25°C, unless otherwise specified)

PARAMETER	SYMBOL	RATINGS	UNIT
Supply Voltage	V _{CC}	-0.5 ~ 7	V
Input Voltage	V _{IN}	-0.5 ~ 7	V
Output Voltage	V _{OUT}	-0.5 ~ V _{CC} +0.5	V
V _{CC} or GND Current	I _{CC}	±50	mA
Output Current	I _{OUT}	±25	mA
Input Clamp Current	I _{IK}	-20	mA
Output Clamp Current	I _{OK}	±20	mA
Storage Temperature	T _{STG}	-65 ~ +150	°C

Note: Absolute maximum ratings are those values beyond which the device could be permanently damaged. Absolute maximum ratings are stress ratings only and functional device operation is not implied.

■ RECOMMENDED OPERATING CONDITIONS

PARAMETER	SYMBOL	CONDITIONS	MIN	TYP	MAX	UNIT
Supply Voltage	V _{CC}		2		5.5	V
Input Voltage	V _{IN}		0		5.5	V
Output Voltage	V _{OUT}	High or low state	0		V _{CC}	V
Operating Temperature	T _A		-40		+125	°C

■ ELECTRICAL CHARACTERISTICS (T_A=25°C, unless otherwise specified)

PARAMETER	SYMBOL	TEST CONDITIONS	MIN	TYP	MAX	UNIT	
Positive-Going Threshold	V _{T+}	V _{CC} =3.0V	1.2		2.2	V	
		V _{CC} =4.5V	1.75		3.15	V	
		V _{CC} =5.5V	2.15		3.85	V	
Negative-Going Threshold	V _{T-}	V _{CC} =3.0V	0.90		1.90	V	
		V _{CC} =4.5V	1.35		2.75	V	
		V _{CC} =5.5V	1.65		3.35	V	
Hysteresis Voltage (V _{T+} -V _{T-})	ΔV _T	V _{CC} =3.0V	0.3		1.2	V	
		V _{CC} =4.5V	0.4		1.4	V	
		V _{CC} =5.5V	0.5		1.6	V	
High-Level Output Voltage	V _{OH}	V _{CC} =2.0V	I _{OH} =-50μA	1.9	2	V	
		V _{CC} =3.0V		2.9	3	V	
		V _{CC} =4.5V	4.4	4.5	V		
		V _{CC} =3.0V, I _{OH} =-4mA	2.58		V		
		V _{CC} =4.5V, I _{OH} =-8mA	3.94		V		
Low-Level Output Voltage	V _{OL}	V _{CC} =2.0V	I _{OL} =50μA			0.1	V
		V _{CC} =3.0V				0.1	V
		V _{CC} =4.5V				0.1	V
		V _{CC} =3.0V, I _{OL} =4mA			0.36	V	
		V _{CC} =4.5V, I _{OL} =8mA			0.36	V	
Input Leakage Current	I _{I(LEAK)}	V _{CC} =0~5.5V, V _{IN} =5.5V or GND			±0.1	μA	
Quiescent Supply Current	I _Q	V _{CC} =5.5V, V _{IN} =V _{CC} or GND, I _{OUT} =0A			1	μA	
Input Capacitance	C _I	V _{CC} =5.0V, V _{IN} =V _{CC} or GND		2	10	pF	

■ DYNAMIC CHARACTERISTICS ($T_A=25^\circ\text{C}$, unless otherwise specified)

PARAMETER	SYMBOL	TEST CONDITIONS	MIN	TYP	MAX	UNIT	
Propagation Delay Time Input(A) to Output(Y)	t_{PLH}	$V_{CC}=3.3V\pm 0.3V$		8.3	12.8	ns	
		$V_{CC}=5V\pm 0.5V$		5.5	8.6	ns	
	t_{PHL}	$V_{CC}=3.3V\pm 0.3V$		8.3	12.8	ns	
		$V_{CC}=5V\pm 0.5V$		5.5	8.6	ns	
	t_{PLH}	$V_{CC}=3.3V\pm 0.3V$		$C_L=50\text{pF}$	10.8	16.3	ns
		$V_{CC}=5V\pm 0.5V$			7	10.6	ns
	t_{PHL}	$V_{CC}=3.3V\pm 0.3V$			10.8	16.3	ns
		$V_{CC}=5V\pm 0.5V$			7	10.6	ns

■ OPERATING CHARACTERISTICS ($T_A=25^\circ\text{C}$, unless otherwise specified)

PARAMETER	SYMBOL	TEST CONDITIONS	MIN	TYP	MAX	UNIT
Power Dissipation Capacitance	C_{PD}	$V_{CC}=5V$, $f=1\text{MHz}$, No load		9		pF

■ TEST CIRCUIT AND WAVEFORMS

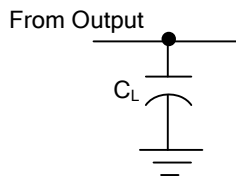

TEST CIRCUIT

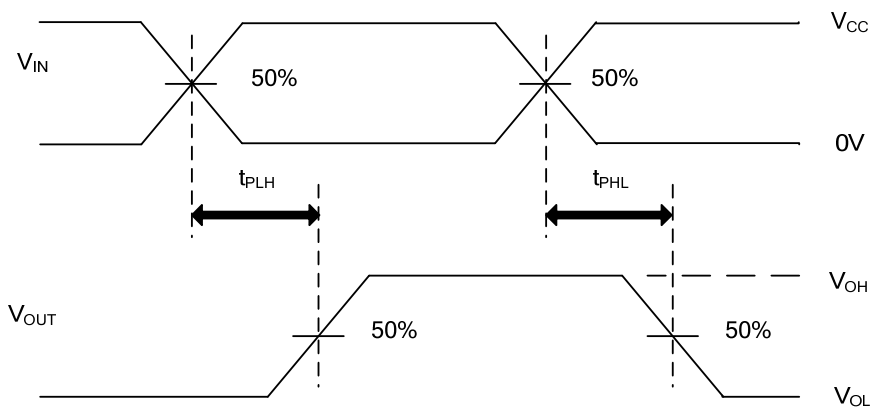

PROPAGATION DELAY TIMES

- Notes: 1. C_L includes probe and jig capacitance.
 2. $P_{RR} \leq 1\text{MHz}$, $Z_O = 50\Omega$, $t_R \leq 3\text{ns}$, $t_F \leq 3\text{ns}$.

UTC assumes no responsibility for equipment failures that result from using products at values that exceed, even momentarily, rated values (such as maximum ratings, operating condition ranges, or other parameters) listed in products specifications of any and all UTC products described or contained herein. UTC products are not designed for use in life support appliances, devices or systems where malfunction of these products can be reasonably expected to result in personal injury. Reproduction in whole or in part is prohibited without the prior written consent of the copyright owner. UTC reserves the right to make changes to information published in this document, including without limitation specifications and product descriptions, at any time and without notice. This document supersedes and replaces all information supplied prior to the publication hereof.