



**UT137FE**

**TRIAC**

**TRIAC**

■ **DESCRIPTION**

Glass passivated, sensitive gate triacs in a full pack plastic envelope, intended for use in general purpose bidirectional switching and phase control applications, where high sensitivity is required in all four quadrants.

■ **SYMBOL**

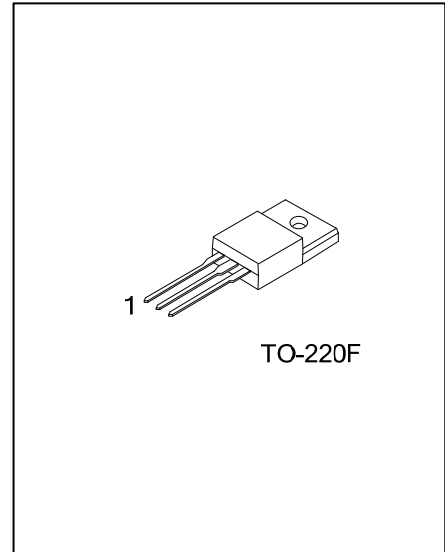
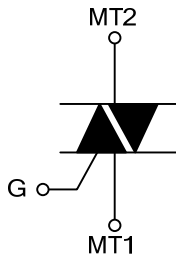

■ **ORDERING INFORMATION**

Ordering Number		Package	Pin Description			Packing
Lead Free	Halogen Free		1	2	3	
UT13FEL-x-TF3-R	UT137FEG-x-TF3-R	TO-220F	MT1	MT2	G	Tube

Note: Pin Assignment: G: Gate

<p>UT137FEL-x-TF3-T</p> <ul style="list-style-type: none"> <li>(1) Packing Type</li> <li>(2) Package Type</li> <li>(3) Peak Voltage</li> <li>(4) Green Package</li> </ul>	<ul style="list-style-type: none"> <li>(1) T: Tube</li> <li>(2) TF3: TO-220F</li> <li>(3) 5: 500V, 6: 600V, 8: 800V</li> <li>(4) L: Lead Free, G: Halogen Free and Lead Free</li> </ul>
---	---

■ **MARKING**

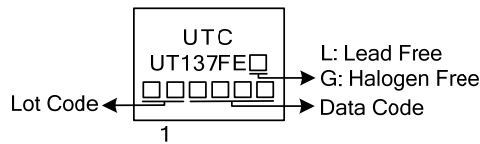

## ■ ABSOLUTE MAXIMUM RATING

PARAMETER		SYMBOL	RATINGS	UNIT
Repetitive Peak Off-State Voltages	UT137FE-5	$V_{DRM}$	500(Note2)	V
	UT137FE-6		600(Note2)	
	UT137FE-8		800	
RMS On-state Current Full sine wave, $T_{HS} \leq 92^{\circ}C$		$I_{T(RMS)}$	8	A
Non-Repetitive Peak. On-State Current Full sine wave, $T_J = 125^{\circ}C$ prior to surge, with reapplied $V_{DRM(MAX)}$	$t = 20$ ms	$I_{TSM}$	55	A
	$t = 16.7$ ms		60	
$I^2t$ For Fusing ( $t = 10$ ms)		$I^2t$	15	$A^2s$
Repetitive Rate of Rise of On-state Current after Triggering $I_{TM} = 12$ A, $I_G = 0.2$ A, $dI_G/dt = 0.2A/\mu s$	T2 + G+	$di_T/dt$	50	A/ $\mu s$
	T2 + G-		50	
	T2 - G-		50	
	T2 - G+		10	
Peak Gate Voltage		$V_{GM}$	5	V
Peak Gate Current		$I_{GM}$	2	A
Peak Gate Power		$P_{GM}$	5	W
Average Gate Power (Over any 20ms period)		$P_{G(AV)}$	0.5	W
Operating Junction Temperature		$T_J$	125	$^{\circ}C$
Storage Temperature		$T_{STG}$	-40 ~ +150	$^{\circ}C$

Notes: 1. Absolute maximum ratings are those values beyond which the device could be permanently damaged. Absolute maximum ratings are stress ratings only and functional device operation is not implied.

2. Although not recommended, off-state voltages up to 800V may be applied without damage, but the triac may switch to the on-state. The rate of rise of current should not exceed 6A/ $\mu s$ .

## ■ THERMAL RESISTANCES

PARAMETER		SYMBOL	MIN	TYP	MAX	UNIT
Thermal resistance Junction to Ambient	In Free Air	$\theta_{JA}$		55		$^{\circ}C/W$
Thermal resistance Junction to mounting base	Full cycle	$\theta_{JC}$			4.5	$^{\circ}C/W$
	Half cycle				6.5	$^{\circ}C/W$

## ■ ISOLATION LIMITING VALUE & CHARACTERISTIC ( $T_{HS} = 25^{\circ}C$ , unless otherwise specified)

PARAMETER	SYMBOL	MIN	TYP	MAX	UNIT
Repetitive peak voltage from all three terminals to external heatsink (R.H. $\leq 65\%$ , clean and dustfree)	$V_{ISOL}$			1500	V
Capacitance from MT2 to external heatsink ( $f = 1$ MHz)	$C_{ISOL}$		12		pF

## ■ STATIC CHARACTERISTICS ( $T_J = 25^{\circ}C$ , unless otherwise specified)

PARAMETER	SYMBOL	TEST CONDITIONS	MIN	TYP	MAX	UNIT	
Gate Trigger Current	$I_{GT}$	$V_D = 12$ V, $I_T = 0.1$ A	T2 + G+		2.5	10	mA
			T2 + G-		4.0	10	mA
			T2 - G-		5.0	10	mA
			T2 - G+		11	25	mA
Latching Current	$I_L$	$V_D = 12$ V, $I_{GT} = 0.1$ A	T2 + G+		3.0	25	mA
			T2 + G-		14	35	mA
			T2 - G-		3.0	25	mA
			T2 - G+		4.0	35	mA
Holding Current	$I_H$	$V_D = 12$ V, $I_{GT} = 0.1$ A		2.5	20	mA	
On-State Voltage	$V_T$	$I_T = 10$ A		1.3	1.65	V	
Gate Trigger Voltage	$V_{GT}$	$V_D = 12$ V, $I_T = 0.1$ A		0.7	1.5	V	
		$V_D = 400$ V, $I_T = 0.1$ A, $T_J = 125^{\circ}C$	0.25	0.4		V	
Off-State Leakage Current	$I_D$	$V_D = V_{DRM(MAX)}$ , $T_J = 125^{\circ}C$		0.1	0.5	mA	

■ DYNAMIC CHARACTERISTICS ( $T_J=25^\circ\text{C}$ , unless otherwise specified)

PARAMETER	SYMBOL	TEST CONDITIONS	MIN	TYP	MAX	UNIT
Critical Rate of Rise of Off-State Voltage	$dV_D/dt$	$V_{DM} = 67\% V_{DRM(MAX)}$ , $T_J=125^\circ\text{C}$ , Exponential waveform, gate open circuit		50		V/ $\mu\text{s}$
Gate Controlled Turn-On Time	$t_{GT}$	$I_{TM} = 12\text{A}$ , $V_D = V_{DRM(MAX)}$ , $I_G = 0.1\text{A}$ , $dI_G/dt = 5\text{A}/\mu\text{s}$		2		$\mu\text{s}$

■ TYPICAL CHARACTERISTICS

Maximum On -State Dissipation.  $P_{tot}$  vs RMS On-State Current,  $I_{T(RMS)}$ , Where  $\alpha$ =conduction Angle

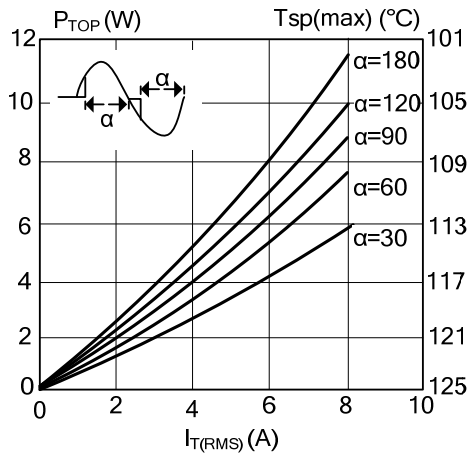

Maximum Permissible RMS Current  $I_{T(RMS)}$  vs Mounting Base Temperature  $T_{mb}$

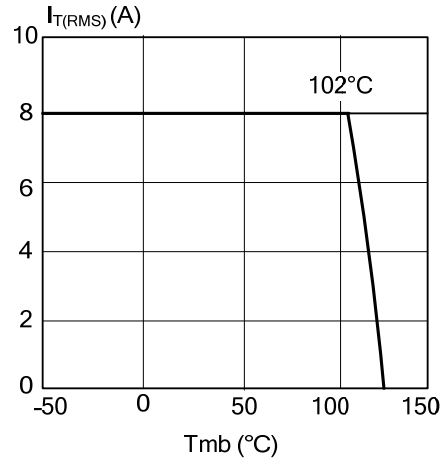

Maximum Permissible Non-Repetitive Peak On-State Current  $I_{TSM}$ , vs Pulse Width  $t_p$ , for Sinusoidal Currents,  $t_p \leq 20ms$

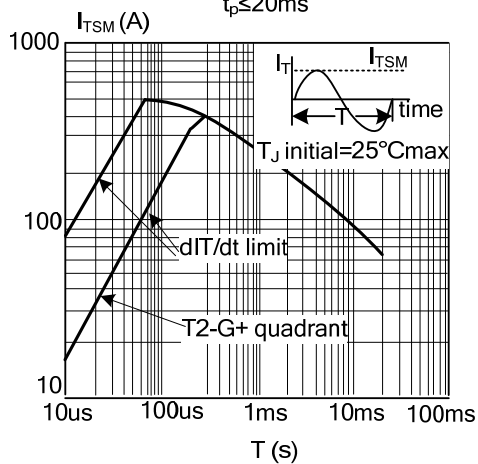

Maximum Permissible Repetitive RMS On-State Current  $I_{T(RMS)}$ , vs Surge Duration, for Sinusoidal Currents,  $f=50Hz$ ,  $T_{mb} \leq 102^\circ C$

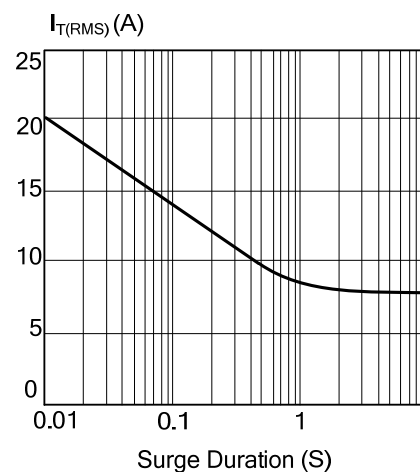

Maximum Permissible Non-Repetitive Peak On-State Current  $I_{TSM}$ , vs Number of Cycles, for Sinusoidal Currents,  $f=50Hz$

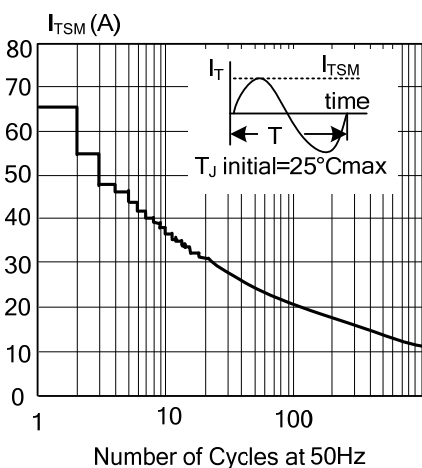

Normalised Gate Trigger Voltage  $V_{GT}(T_J)/V_{GT}(25^\circ C)$ , vs Junction Temperature  $T_J$

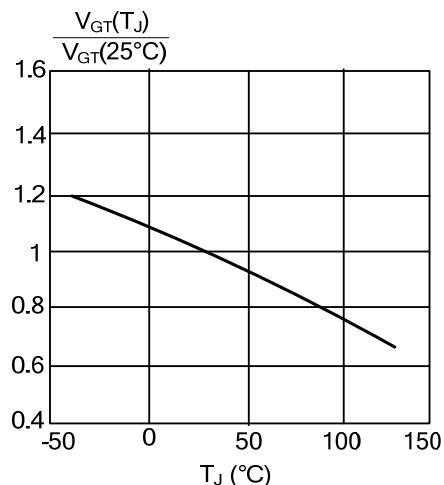

■ TYPICAL CHARACTERISTICS(Cont.)

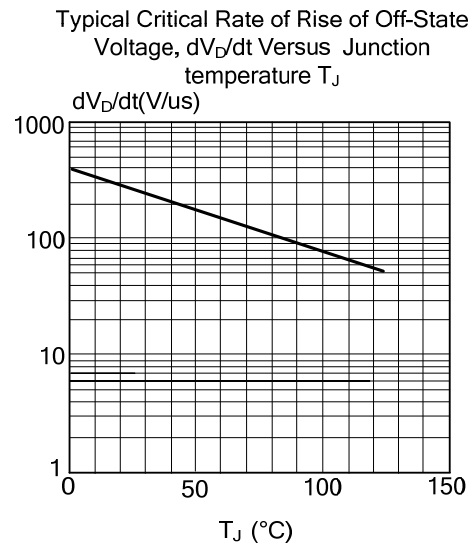
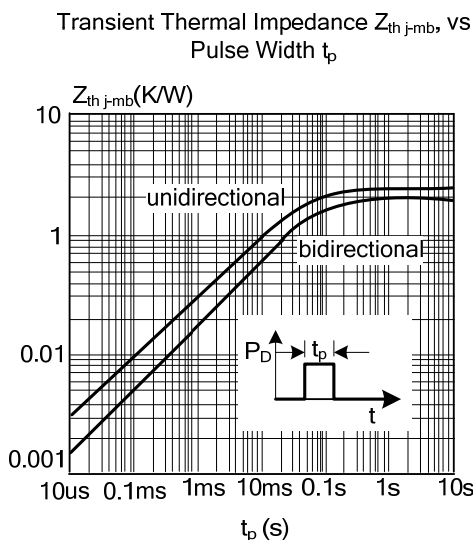
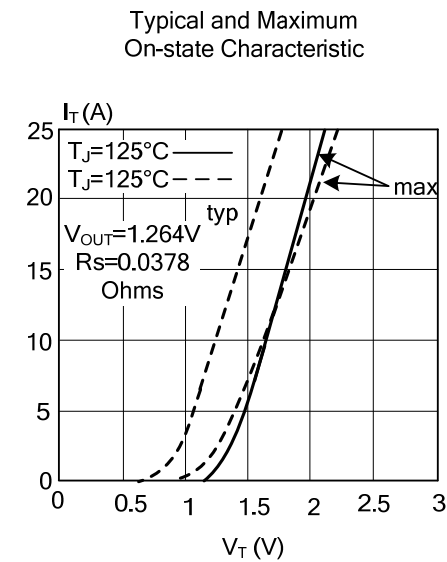
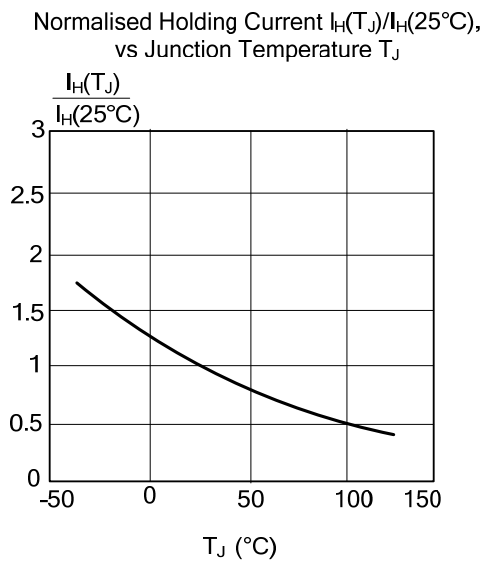
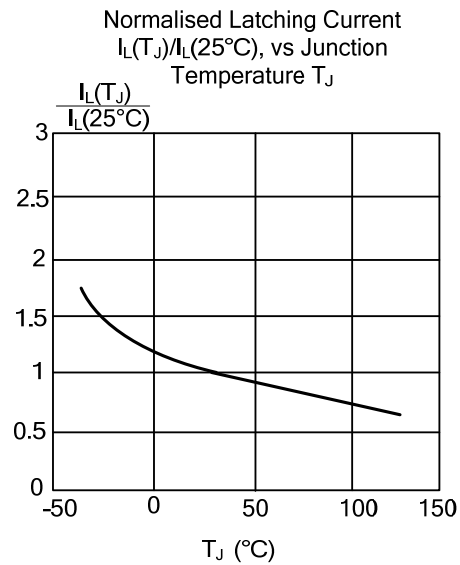
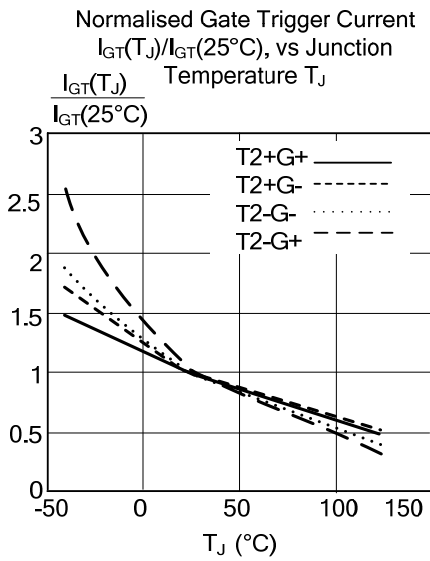

UTC assumes no responsibility for equipment failures that result from using products at values that exceed, even momentarily, rated values (such as maximum ratings, operating condition ranges, or other parameters) listed in products specifications of any and all UTC products described or contained herein. UTC products are not designed for use in life support appliances, devices or systems where malfunction of these products can be reasonably expected to result in personal injury. Reproduction in whole or in part is prohibited without the prior written consent of the copyright owner. The information presented in this document does not form part of any quotation or contract, is believed to be accurate and reliable and may be changed without notice.