



UT138F/G

TRIAC

TRIACS

■ **DESCRIPTION**

Passivated triacs in a plastic envelope, intended for use in applications requiring high bidirectional transient and blocking voltage capability and high thermal cycling performance. Typical applications include motor control, industrial and domestic lighting, heating and static switching.

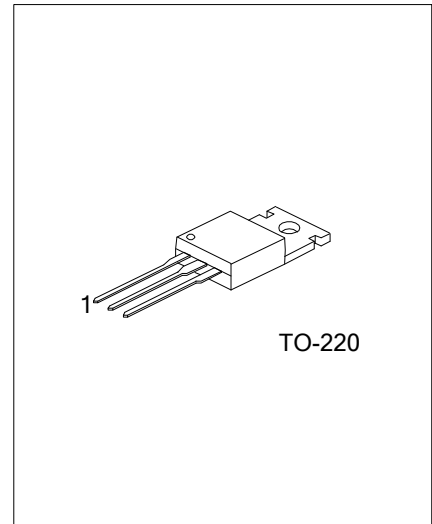

■ **SYMBOL**

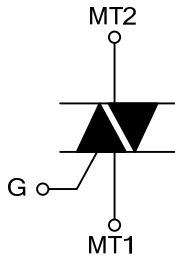

■ **ORDERING INFORMATION**

Order Number		Package	Pin Assignment			Packing
Normal	Lead Free Plating		1	2	3	
UT138FL-x-TA3-T	UT138FG-x-TA3-T	TO-220	MT1	MT2	G	Tube
UT138GL-x-TA3-T	UT138GP-x-TA3-T	TO-220	MT1	MT2	G	Tube

Note: Pin Assignment: G: Gate

<p>UT138FL-x-TA3-T</p> <ul style="list-style-type: none"> (1) Packing Type (2) Package Type (3) Peak Voltage (4) Green Package 	<ul style="list-style-type: none"> (1) T: Tube (2) TA3: TO-220 (3) 5: 500V, 6: 600V, 8: 800V (4) L: Lead Free, G: Halogen Free and Lead Free P: Halogen Free and Lead Free
--------------------------------------------------------------------------------------------------------------------------------------------------------------------------	-------------------------------------------------------------------------------------------------------------------------------------------------------------------------------------------------------------------------------

■ **MARKING**

UT138F	UT138G

■ ABSOLUTE MAXIMUM RATING ($T_J=25^{\circ}\text{C}$, unless otherwise specified)

PARAMETER		SYMBOL	RATINGS	UNIT
Repetitive peak off-state voltages	UT138F_G-5	V_{DRM}	500 (Note 2)	V
	UT138F_G-6		600 (Note 2)	V
	UT138F_G-8		800	V
RMS on-state current full sine wave; $T_{\text{mb}} \leq 99^{\circ}\text{C}$		$I_{\text{T(RMS)}}$	12	A
Non-repetitive peak on-state current (Full sine wave; $T_J = 25^{\circ}\text{C}$ prior to surge)	$t = 20\text{ms}$	I_{TSM}	95	A
	$t = 16.7\text{ms}$		105	
I^2t for fusing	$t = 10\text{ms}$	I^2t	45	A^2s
Repetitive rate of rise of on-state current after triggering $I_{\text{TM}}=20\text{A}$; $I_{\text{G}}=0.2\text{A}$; $dI_{\text{G}}/dt=0.2\text{A}/\mu\text{s}$	T2+ G+	dI_{T}/dt	50	$\text{A}/\mu\text{s}$
	T2+ G-		50	$\text{A}/\mu\text{s}$
	T2- G-		50	$\text{A}/\mu\text{s}$
	T2- G+		10	$\text{A}/\mu\text{s}$
Peak gate voltage		V_{GM}	5	V
Peak gate current		I_{GM}	2	A
Peak gate power		P_{GM}	5	W
Average gate power (over any 20 ms period)		$P_{\text{G(AV)}}$	0.5	W
Junction Temperature		T_J	125	$^{\circ}\text{C}$
Storage Temperature		T_{STG}	-40 ~ +150	$^{\circ}\text{C}$

Note: 1. Absolute maximum ratings are those values beyond which the device could be permanently damaged. Absolute maximum ratings are stress ratings only and functional device operation is not implied.

2. Although not recommended, off-state voltages up to 800V may be applied without damage, but the triac may switch to the on-state. The rate of rise of current should not exceed $15\text{A}/\mu\text{s}$.

■ THERMAL RESISTANCES

PARAMETER		SYMBOL	MIN	TYP	MAX	UNIT
Thermal resistance Junction to Ambient	In Free Air	θ_{JA}		60		$^{\circ}\text{C}/\text{W}$
Thermal resistance Junction to mounting base	Full cycle	θ_{JC}			1.5	$^{\circ}\text{C}/\text{W}$
	Half cycle				2.0	$^{\circ}\text{C}/\text{W}$

■ STATIC CHARACTERISTICS ($T_J=25^{\circ}\text{C}$, unless otherwise specified)

PARAMETER	SYMBOL	TEST CONDITIONS	MIN	TYP	MAX		UNIT
					UT138F	UT138G	
Gate Trigger Current	I_{GT}	$V_{\text{D}}=12\text{V}$, $I_{\text{T}}=0.1\text{A}$	T2+G+	5	25	50	mA
			T2+G-	8	25	50	
			T2-G-	11	25	50	
			T2-G+	20	70	100	
Latching Current	I_{L}	$V_{\text{D}}=12\text{V}$, $I_{\text{GT}}=0.1\text{A}$	T2+G+	7	40	60	mA
			T2+G-	20	60	90	
			T2-G-	8	40	60	
			T2-G+	10	60	90	
Holding Current	I_{H}	$V_{\text{D}}=12\text{V}$, $I_{\text{GT}}=0.1\text{A}$		6	30	60	mA
On-State Voltage	V_{T}	$I_{\text{T}}=15\text{A}$		1.4	1.65		V
Gate Trigger Voltage	V_{GT}	$V_{\text{D}}=12\text{V}$, $I_{\text{T}}=0.1\text{A}$		0.7	1.5		V
		$V_{\text{D}}=400\text{V}$, $I_{\text{T}}=0.1\text{A}$, $T_J=125^{\circ}\text{C}$	0.25	0.4			V
Off-State Leakage Current	I_{D}	$V_{\text{D}}=V_{\text{DRM(max)}}$, $T_J=125^{\circ}\text{C}$		0.1	0.5		mA

■ DYNAMIC CHARACTERISTICS ($T_J=25^\circ\text{C}$, unless otherwise specified)

PARAMETER	SYMBOL	TEST CONDITIONS	MIN		TYP	MAX	UNIT
			UT138F	UT138G			
Critical Rate Of Rise Of Off-State Voltage	dV_D/dt	$V_{DM}=67\% V_{DRM(max)}$, $T_J=125^\circ\text{C}$, Exponential waveform, gate open circuit	50	200	250		V/ μs
Critical Rate Of Change Of Commutating Voltage	dV_{com}/dt	$V_{DM}=400\text{V}$, $T_J=95^\circ\text{C}$, $I_{T(RMS)}=12\text{A}$, $dI_{com}/dt=5.4\text{A/ms}$, gate open circuit		10	20		V/ μs
Gate Controlled Turn-On Time	t_{gt}	$I_{TM}=16\text{A}$, $V_D=V_{DRM(max)}$, $I_G=0.1\text{A}$, $dI_G/dt=5\text{A}/\mu\text{s}$			2		μs

■ TYPICAL CHARACTERISTICS

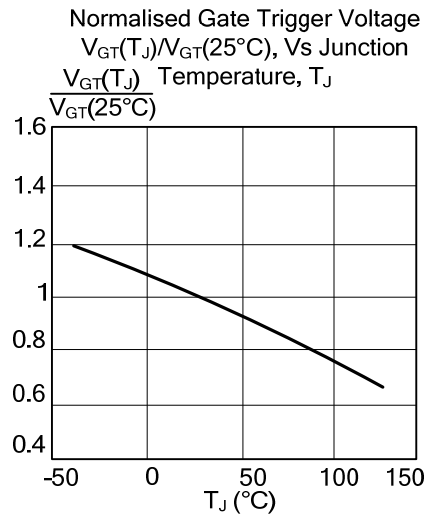
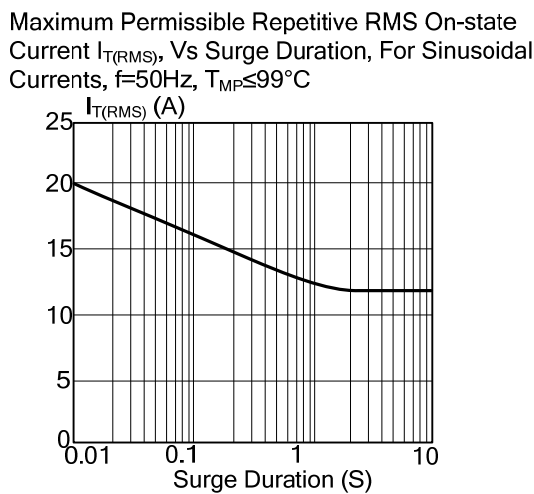
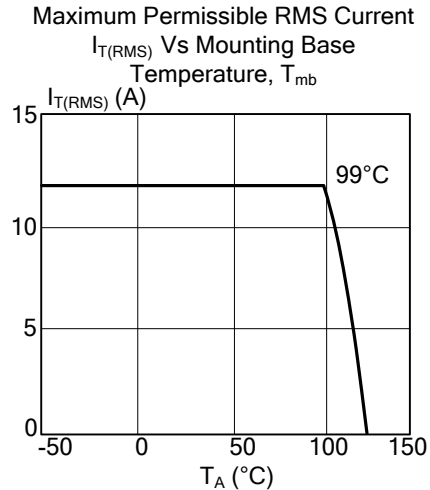
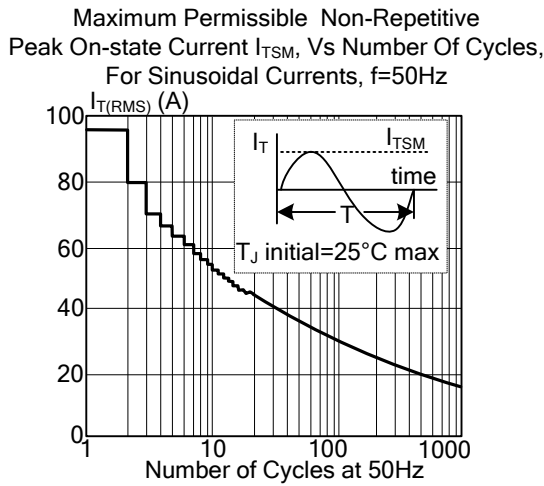
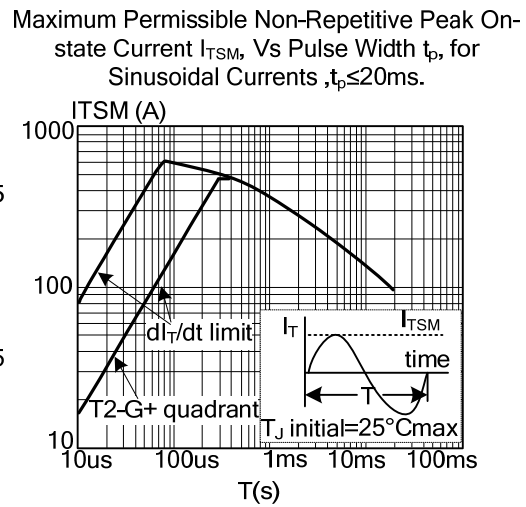
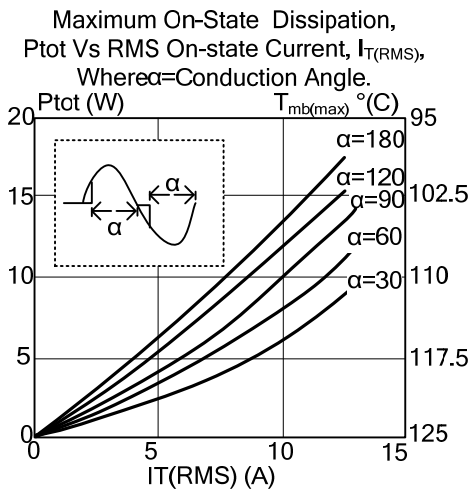

■ TYPICAL CHARACTERISTICS (Cont.)

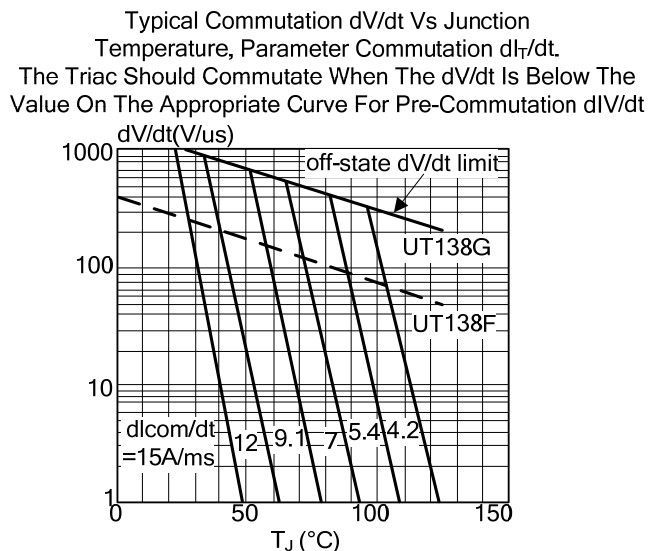
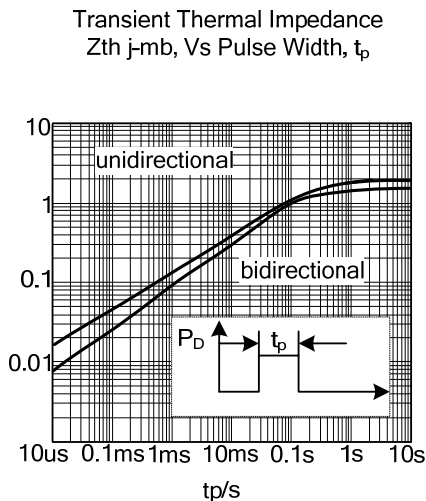
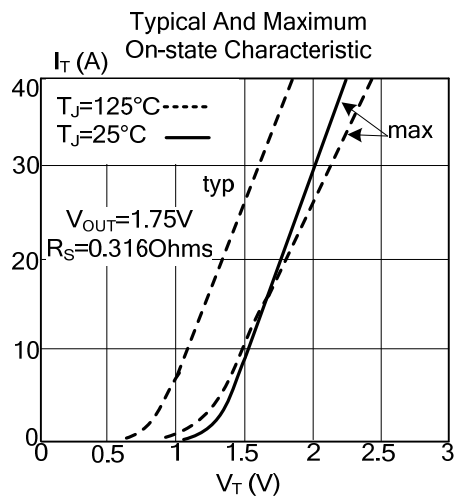
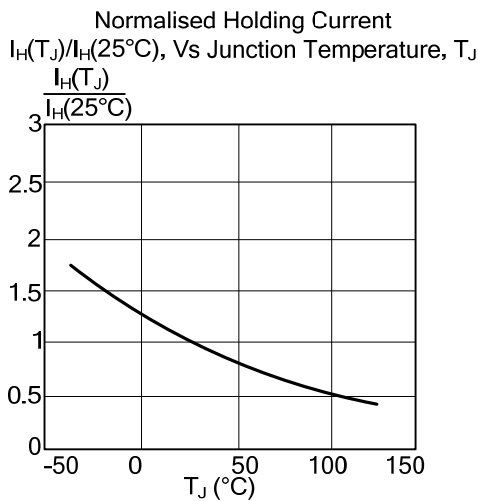
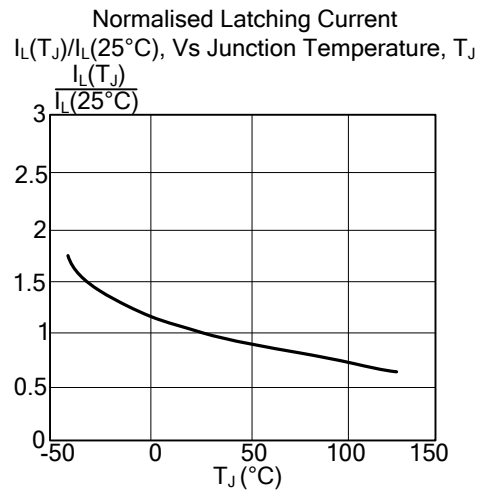
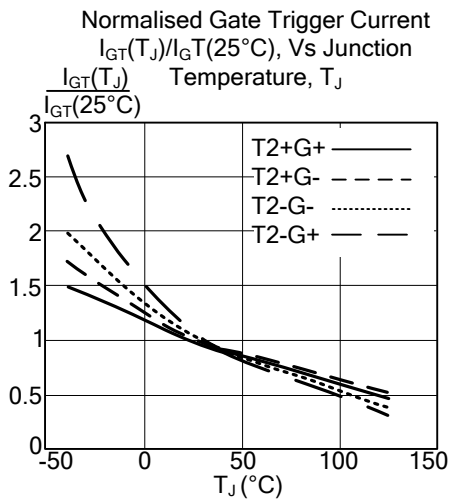

UTC assumes no responsibility for equipment failures that result from using products at values that exceed, even momentarily, rated values (such as maximum ratings, operating condition ranges, or other parameters) listed in products specifications of any and all UTC products described or contained herein. UTC products are not designed for use in life support appliances, devices or systems where malfunction of these products can be reasonably expected to result in personal injury. Reproduction in whole or in part is prohibited without the prior written consent of the copyright owner. UTC reserves the right to make changes to information published in this document, including without limitation specifications and product descriptions, at any time and without notice. This document supersedes and replaces all information supplied prior to the publication hereof.