



UT137E

TRIAC

TRIAC

DESCRIPTION

Passivated, sensitive gate triacs in a plastic envelope, intended for use in general purpose bidirectional switching and phase control applications, where high sensitivity is required in all four quadrants.

SYMBOL

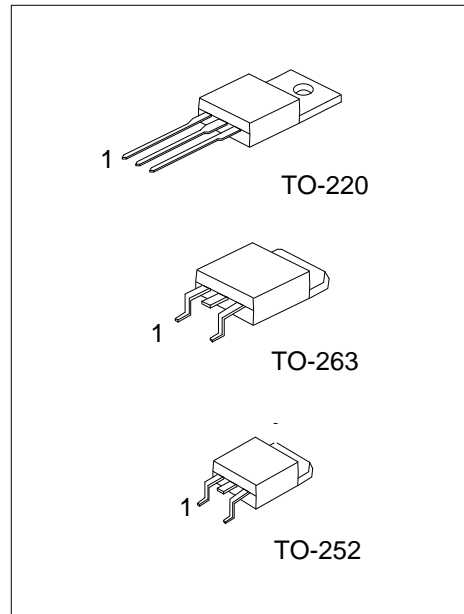
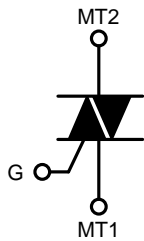

ORDERING INFORMATION

Order Number		Package	Pin Assignment			Packing
Lead Free	Halogen Free		1	2	3	
UT137EL-x-TA3-T	UT137EG-x-TA3-T	TO-220	MT1	MT2	GATE	Tube
UT137EL-x-TN3-R	UT137EG-x-TN3-R	TO-252	MT1	MT2	GATE	Tape Reel
UT137EL-x-TQ2-T	UT137EG-x-TQ2-T	TO-263	MT1	MT2	GATE	Tube
UT137EL-x-TQ2-R	UT137EG-x-TQ2-R	TO-263	MT1	MT2	GATE	Tape Reel

<p>UT137EG-x-TA3-T</p> <p>(1)Packing Type</p> <p>(2)Package Type</p> <p>(3)Peak Voltage</p> <p>(4)Green Package</p>	<p>(1) T: Tube, R: Tape Reel</p> <p>(2) TA3: TO-220, TN3: TO-252, TQ2: TO-263</p> <p>(3) 5: 500V, 6: 600V, 8: 800V</p> <p>(4) G: Halogen Free and Lead Free, L: Lead Free</p>
---	---

MARKING

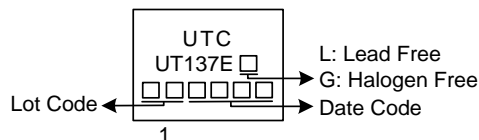

■ ABSOLUTE MAXIMUM RATING

PARAMETER		SYMBOL	RATINGS	UNIT
Repetitive peak off-state voltages	UT137E-5	V_{DRM}	500 (Note 2)	V
	UT137E-6		600 (Note 2)	V
	UT137E-8		800	V
RMS on-state current full sine wave; $T_{mb} \leq 102^{\circ}C$		$I_{T(RMS)}$	8	A
Non-repetitive peak on-state current (Full sine wave; $T_J = 25^{\circ}C$ prior to surge)	$t = 20ms$	I_{TSM}	65	A
	$t = 16.7 ms$		71	
I^2t for fusing	$t = 10 ms$	I^2t	21	A^2s
Repetitive rate of rise of on-state current after triggering $I_{TM}=12A; I_G=0.2A; dI_G/dt=0.2A/\mu s$	T2+ G+	di_T/dt	50	$A/\mu s$
	T2+ G-		50	$A/\mu s$
	T2- G-		50	$A/\mu s$
	T2- G+		10	$A/\mu s$
Peak gate voltage		V_{GM}	5	V
Peak gate current		I_{GM}	2	A
Peak gate power		P_{GM}	5	W
Average gate power (over any 20 ms period)		$P_{G(AV)}$	0.5	W
Junction Temperature		T_J	125	$^{\circ}C$
Storage Temperature		T_{STG}	-40 ~ +150	$^{\circ}C$

Note: 1. Absolute maximum ratings are those values beyond which the device could be permanently damaged. Absolute maximum ratings are stress ratings only and functional device operation is not implied.

2. Although not recommended, off-state voltages up to 800V may be applied without damage, but the triac may switch to the on-state. The rate of rise of current should not exceed $6A/\mu s$.

■ THERMAL DATA

PARAMETER			SYMBOL	MIN	TYP	MAX	UNIT	
Thermal resistance Junction to Ambient	In Free Air	TO-220	θ_{JA}		60		$^{\circ}C/W$	
		TO-263						
		TO-252						
Thermal resistance Junction to mounting base	Full cycle	TO-220	θ_{JC}			2.0	$^{\circ}C/W$	
		TO-263						
		TO-252						
	Half cycle	TO-220					2.4	$^{\circ}C/W$
		TO-263						
		TO-252						

■ STATIC CHARACTERISTICS ($T_J=25^{\circ}C$, unless otherwise stated)

PARAMETER	SYMBOL	TEST CONDITIONS	MIN	TYP	MAX	UNIT
Gate trigger current	I_{GT}	$V_D = 12 V; I_T = 0.1 A$	T2+G+	2.5	10	mA
			T2+G-	4.0	10	mA
			T2-G-	5.0	10	mA
			T2-G+	11	25	mA
Latching current	I_L	$V_D = 12 V; I_{GT} = 0.1 A$	T2+G+	3.0	25	mA
			T2+G-	14	35	mA
			T2-G-	3.0	25	mA
			T2-G+	4.0	35	mA
Holding current	I_H	$V_D = 12 V; I_{GT} = 0.1 A$		2.5	20	mA
On-state voltage	V_T	$I_T = 10 A$		1.3	1.65	V
Gate trigger voltage	V_{GT}	$V_D = 12 V; I_T = 0.1 A$		0.7	1.5	V
		$V_D = 400V; I_T = 0.1 A; T_J = 125^{\circ}C$	0.25	0.4		V
Off-state leakage current	I_D	$V_D = V_{DRM(max)}; T_J = 125^{\circ}C$		0.1	0.5	mA

■ DYNAMIC CHARACTERISTICS (T_J=25°C, unless otherwise stated)

parameter	symbol	conditions	min	typ	max	unit
Critical rate of rise of Off-state voltage	d_{VD} / dt	$V_{DM} = 67\% V_{DRMMAX}$; T _J =125°C; Exponential waveform; gate open circuit		50		V/μs
Gate controlled turn-on time	t_{GT}	I _{TM} = 12A; V _D = V _{DRMMAX} ; I _G =0.1A; d _{I_G} /dt=5A/μs		2		μs

■ TYPICAL CHARACTERISTICS

Figure 1. Maximum On -State Dissipation. P_{tot} vs RMS On-State Current, $I_{T(RMS)}$, Where α =conduction Angle

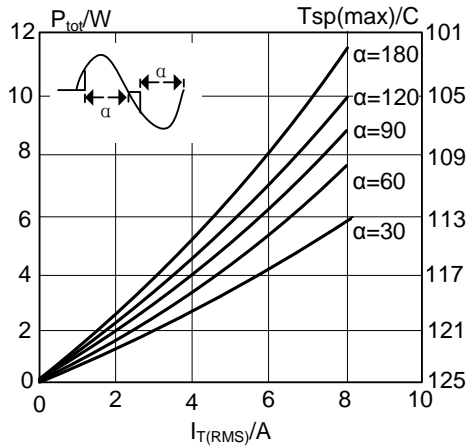

Figure 2. Maximum Permissible Non-Repetitive Peak On-State Current I_{TSM} , vs Pulse Width t_p , for Sinusoidal Currents, $t_p \leq 20ms$

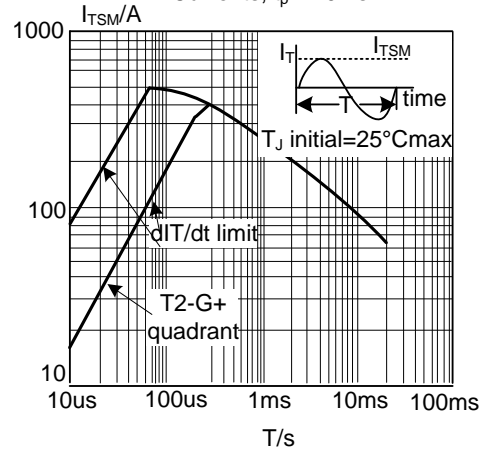

Figure 3. Maximum Permissible Non-Repetitive Peak On-State Current I_{TSM} , vs Number of Cycles, for Sinusoidal Currents, $f=50Hz$

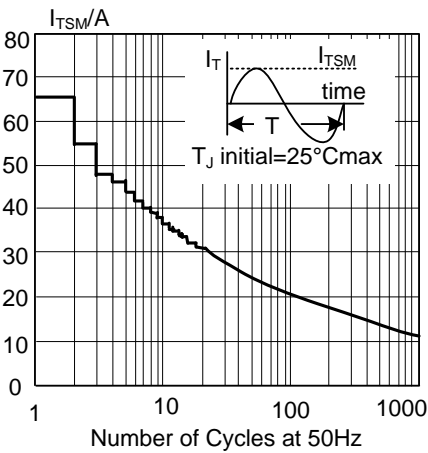

Figure 4. Maximum Permissible RMS Current $I_{T(RMS)}$ vs Mounting Base Temperature T_{mb}

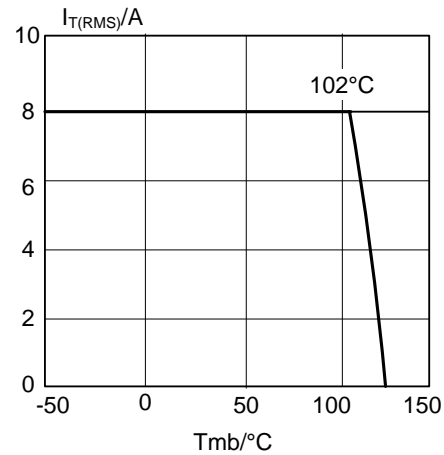

Figure 5. Maximum Permissible Repetitive RMS On-State Current $I_{T(RMS)}$, vs Surge Duration, for Sinusoidal Currents, $f=50Hz$, $T_{mb} \leq 102^\circ$ C

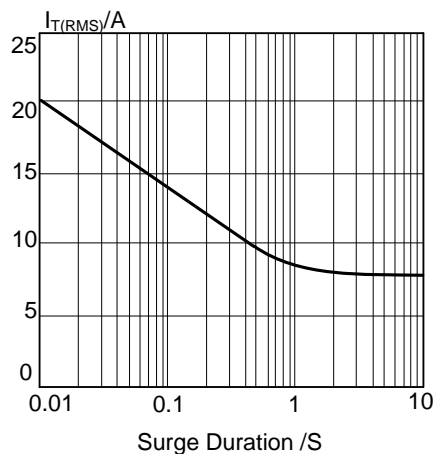
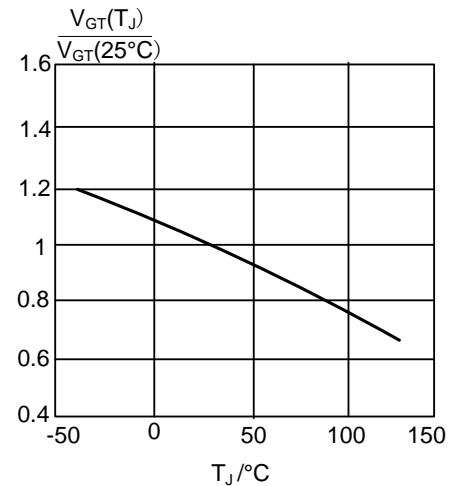

Figure 6. Normalised Gate Trigger Voltage $V_{GT}(T_J)/V_{GT}(25^\circ$ C), vs Junction Temperature T_J



■ TYPICAL CHARACTERISTICS(Cont.)

Figure 7. Normalised Gate Trigger Current $I_{GT}(T_J)/I_{GT}(25^\circ\text{C})$, vs Junction Temperature T_J

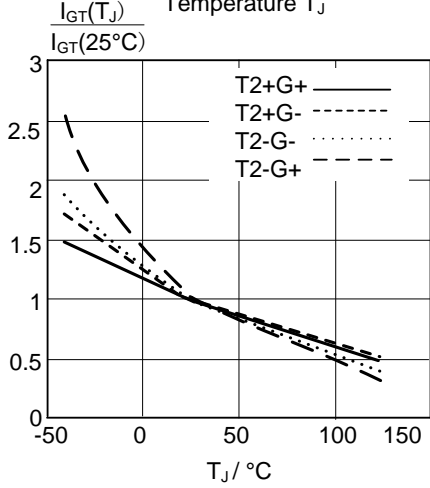

Figure 8. Normalised Latching Current $I_L(T_J)/I_L(25^\circ\text{C})$, vs Junction Temperature T_J

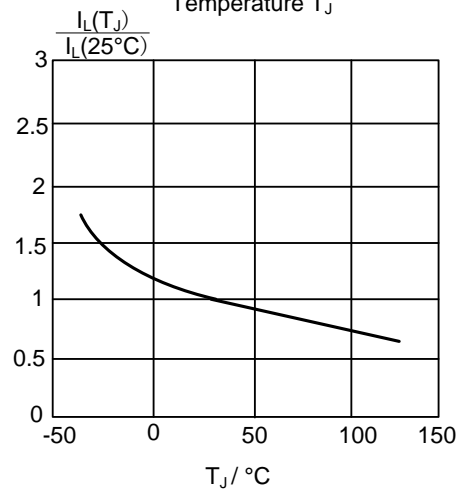

Figure 9. Normalised Holding Current $I_H(T_J)/I_H(25^\circ\text{C})$, vs Junction Temperature T_J

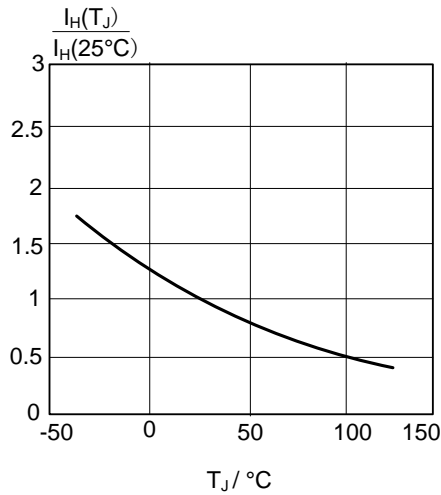

Figure 10. Typical and Maximum On-state Characteristic

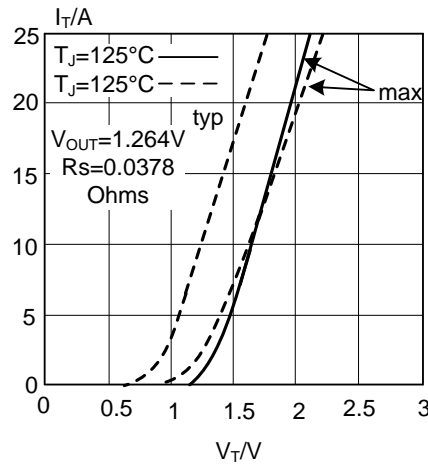

Figure 11. Transient Thermal Impedance $Z_{th\ j-mb}$, vs Pulse Width t_p

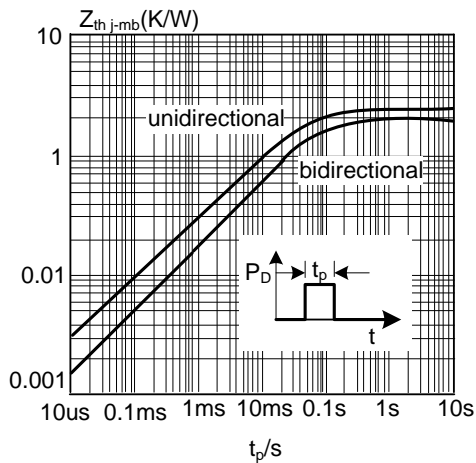
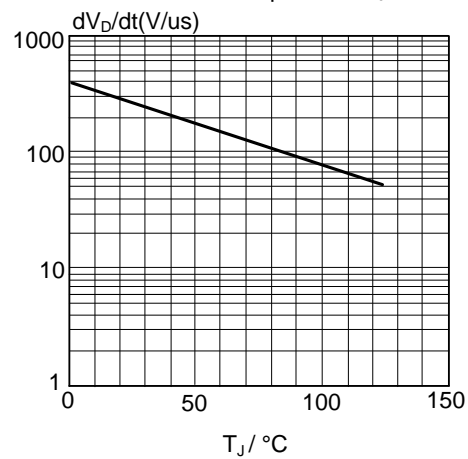

Figure 12. Typical Critical Rate of Rise of Off-State Voltage, dV_D/dt Versus Junction temperature T_J



UTC assumes no responsibility for equipment failures that result from using products at values that exceed, even momentarily, rated values (such as maximum ratings, operating condition ranges, or other parameters) listed in products specifications of any and all UTC products described or contained herein. UTC products are not designed for use in life support appliances, devices or systems where malfunction of these products can be reasonably expected to result in personal injury. Reproduction in whole or in part is prohibited without the prior written consent of the copyright owner. UTC reserves the right to make changes to information published in this document, including without limitation specifications and product descriptions, at any time and without notice. This document supersedes and replaces all information supplied prior to the publication hereof.