



UN1518

NPN SILICON TRANSISTOR

POWER (SWITCHING) TRANSISTOR

■ FEATURES

- * Bipolar Power Transistor
- * High Current Switching
- * High h_{FE}
- * Low $V_{CE(SAT)}$

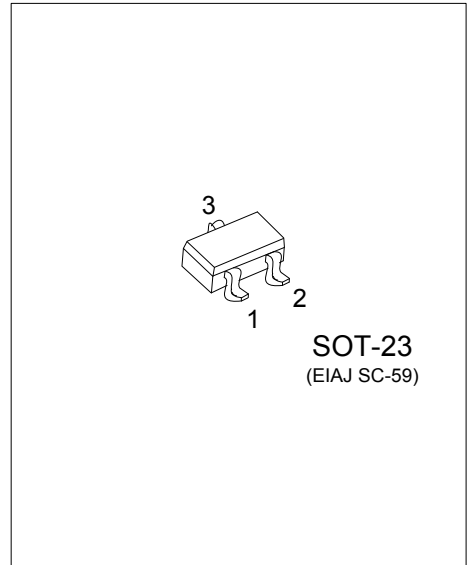

■ ORDERING INFORMATION

Ordering Number		Package	Pin Assignment			Packing
Lead Free	Halogen Free		1	2	3	
UN1518L-AE3-R	UN1518G-AE3-R	SOT-23	B	E	C	Tape Reel

Note: Pin Assignment: B: Base E: Emitter C: Collector

UN1518G-AE3-R		
(1) Packing Type	(1) R: Tape Reel	
(2) Package Type	(2) AE3: SOT-23	
(3) Green Package	(3) G: Halogen Free and Lead Free, L: Lead Free	

■ MARKING

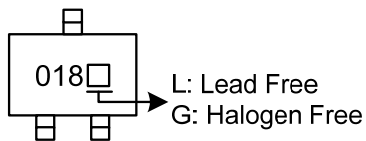

■ ABSOLUTE MAXIMUM RATINGS ($T_C = 25^\circ\text{C}$, unless otherwise stated)

PARAMETER		SYMBOL	RATINGS	UNIT
Collector-Base Voltage		V_{CBO}	20	V
Collector-Emitter Voltage		V_{CEO}	20	V
Emitter-Base Voltage		V_{EBO}	5	V
Collector Current	Pulse (Note 2)	I_{CM}	6	A
	DC	I_C	2.5	A
Base Current		I_B	500	mA
Total Device Dissipation		P_D	625	mW
Storage Temperature		T_{STG}	-50 ~ +150	$^\circ\text{C}$

Notes: 1. Absolute maximum ratings are those values beyond which the device could be permanently damaged.

Absolute maximum ratings are stress ratings only and functional device operation is not implied.

2. Pulse width=300 μs . Duty cycle $\leq 2\%$.

■ ELECTRICAL CHARACTERISTICS

PARAMETER	SYMBOL	TEST CONDITIONS	MIN	TYP	MAX	UNIT
Collector-Base Breakdown Voltage	BV_{CBO}	$I_C=100\mu\text{A}$	20	100		V
Collector-Emitter Breakdown Voltage	BV_{CEO}	$I_C=10\text{mA}$ (Note)	20	27		V
Emitter-Base Breakdown Voltage	BV_{EBO}	$I_E=100\mu\text{A}$	5	8.3		V
Collector Cut-Off Current	I_{CBO}	$V_{CB}=16\text{V}$			100	nA
Emitter Cut-Off Current	I_{EBO}	$V_{EB}=4\text{V}$			100	nA
Collector Emitter Cut-Off Current	I_{CES}	$V_{CES}=16\text{V}$			100	nA
Collector-Emitter Saturation Voltage (Note)	$V_{CE(SAT)}$	$I_C=0.1\text{A}, I_B=10\text{mA}$		10	15	mV
		$I_C=1\text{A}, I_B=10\text{mA}$		70	150	mV
		$I_C=2.5\text{A}, I_B=50\text{mA}$		200	250	mV
Base-Emitter Saturation Voltage (Note)	$V_{BE(SAT)}$	$I_C=2.5\text{A}, I_B=50\text{mA}$		0.89	1.0	V
Base-Emitter Turn-On Voltage (Note)	$V_{BE(ON)}$	$V_{CE}=2\text{V}, I_C=2.5\text{A}$		0.79	1.0	V
DC Current Gain (Note)	h_{FE}	$V_{CE}=2\text{V}, I_C=10\text{mA}$	200	400		
		$V_{CE}=2\text{V}, I_C=200\text{mA}$	300	450		
		$V_{CE}=2\text{V}, I_C=2\text{A}$	200	360		
		$V_{CE}=2\text{V}, I_C=6\text{A}$	100	180		
Transition Frequency	f_T	$V_{CE}=10\text{V}, I_C=50\text{mA}, f=100\text{MHz}$	100	140		MHz
Output Capacitance	C_{OB}	$V_{CB}=10\text{V}, f=1\text{MHz}$		23	30	pF
Turn-On Time	$t_{(ON)}$	$V_{CC}=10\text{V}, I_C=1\text{A}, I_{B1}=-I_{B2}=10\text{mA}$		170		nS
Turn-Off Time	$t_{(OFF)}$			400		nS

Note: Pulse Test: Pulse Width $\leq 300\mu\text{s}$, Duty Cycle $\leq 2.0\%$.

■ TYPICAL CHARACTERISTICS ($T_A=25^\circ\text{C}$)

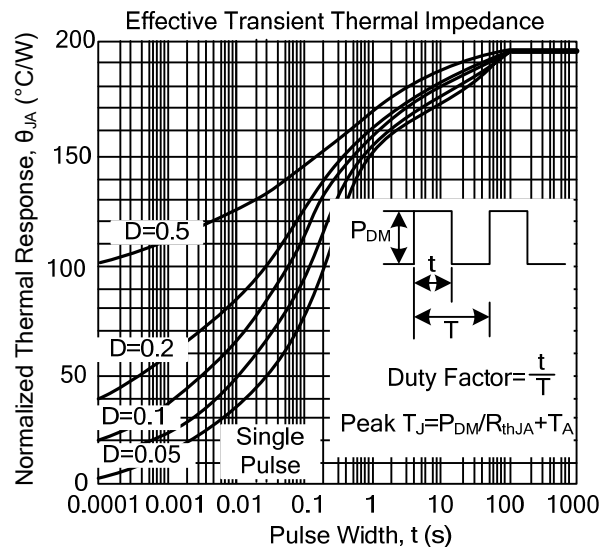
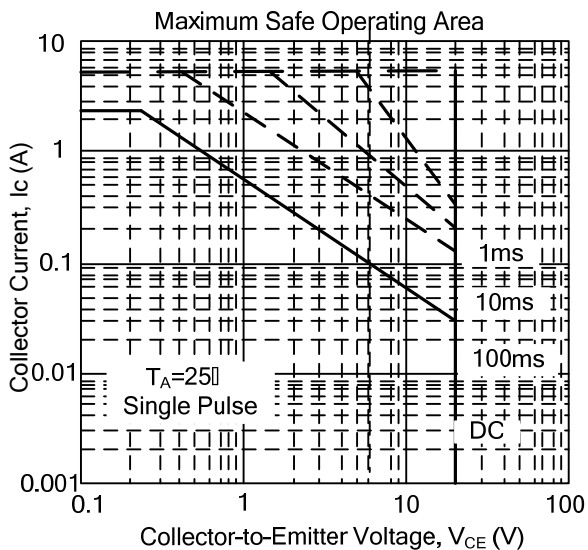
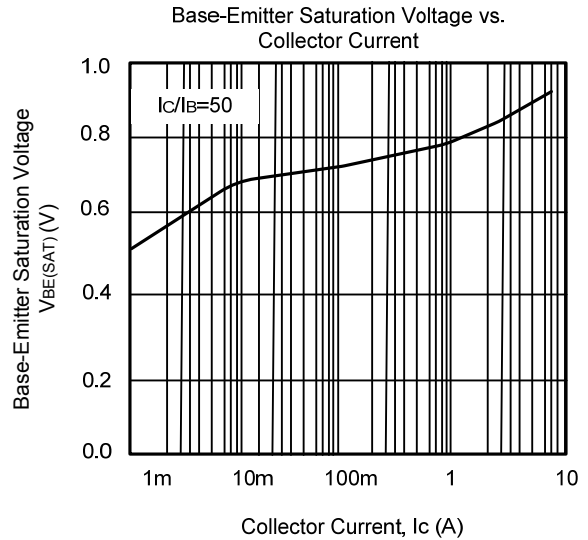
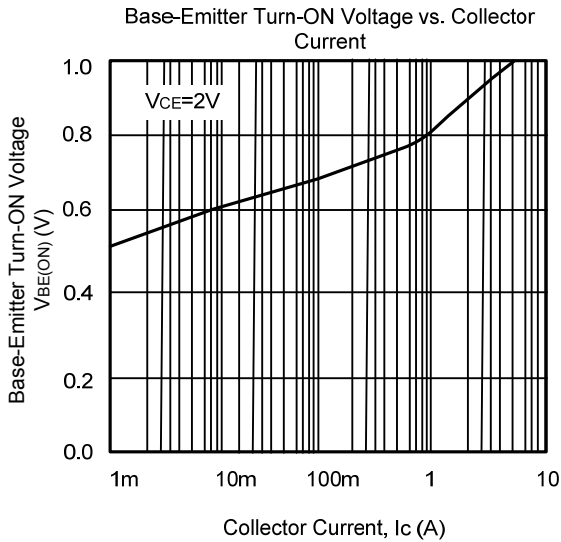
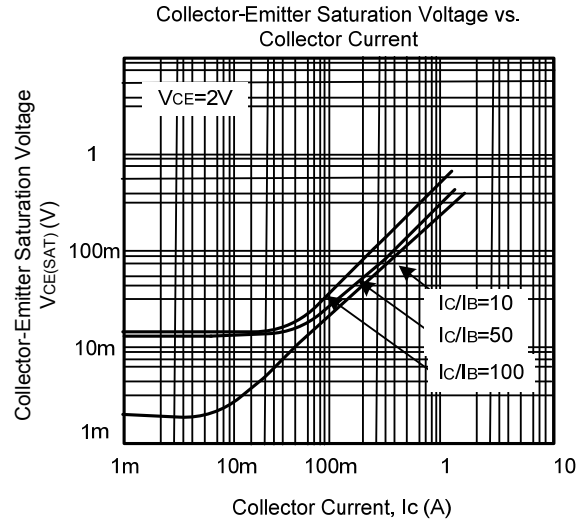
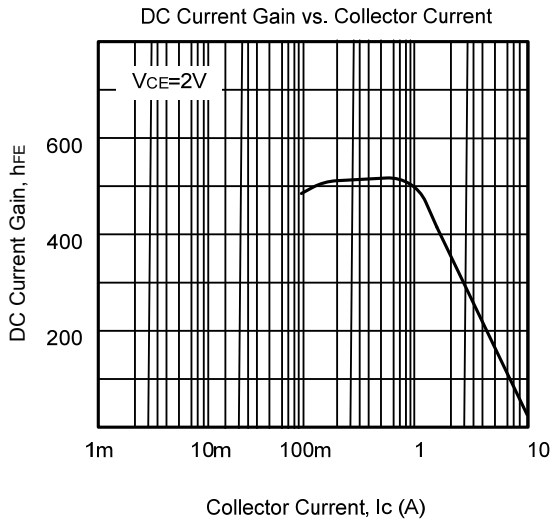

UTC assumes no responsibility for equipment failures that result from using products at values that exceed, even momentarily, rated values (such as maximum ratings, operating condition ranges, or other parameters) listed in products specifications of any and all UTC products described or contained herein. UTC products are not designed for use in life support appliances, devices or systems where malfunction of these products can be reasonably expected to result in personal injury. Reproduction in whole or in part is prohibited without the prior written consent of the copyright owner. UTC reserves the right to make changes to information published in this document, including without limitation specifications and product descriptions, at any time and without notice. This document supersedes and replaces all information supplied prior to the publication hereof.