



2SD718

NPNEPITAXIAL SILICON TRANSISTOR

HIGH POWER AMPLIFIER APPLICATION

FEATURES

- * Recommended for 45~50W Audio Frequency Amplifier Output Stage.
- * Complementary to 2SB688.

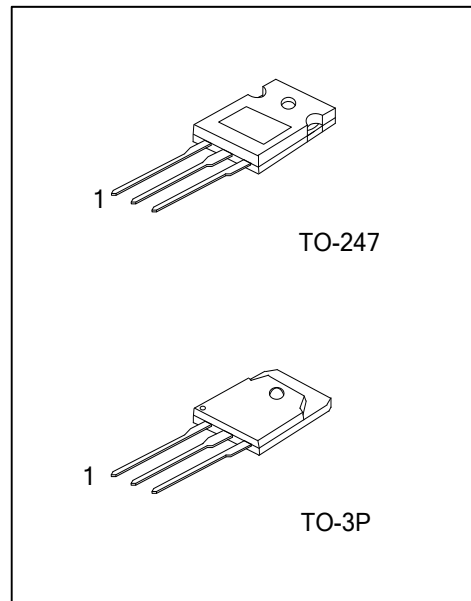

ORDERING INFORMATION

Ordering Number		Package	Pin Assignment			Packing
Lead Free	Halogen Free		1	2	3	
2SD718L-x-T47-T	2SD718G-x-T47-T	TO-247	B	C	E	Tube
2SD718L-x-T3P-T	2SD718G-x-T3P-T	TO-3P	B	C	E	Tube

Note: Pin Assignment: B: Base C: Collector E: Emitter

<p>2SD718G-x-T47-T</p>	<p>(1) T: Tube (2) T47: TO-247, T3P: TO-3P (3) x: refer to Classification of h_{FE} (4) G: Halogen Free and Lead Free, L: Lead Free</p>
------------------------	--

MARKING

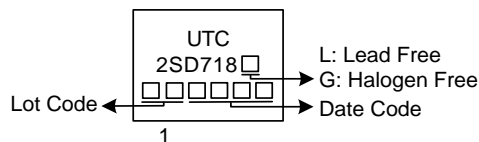

■ ABSOLUTE MAXIMUM RATING ($T_A=25^\circ\text{C}$, unless otherwise specified)

PARAMETER		SYMBOL	RATINGS	UNIT
Collector-Base Voltage		V_{CBO}	120	V
Collector-Emitter Voltage		V_{CEO}	120	V
Emitter-Base Voltage		V_{EBO}	5	V
Collector Current		I_C	10	A
Base Current		I_B	1	A
Collector Power Dissipation ($T_C=25^\circ\text{C}$)	TO-247	P_C	78	W
	TO-3P		80	W
Junction Temperature		T_J	+150	$^\circ\text{C}$
Storage Temperature Range		T_{STG}	-55 ~ +150	$^\circ\text{C}$

Note: Absolute maximum ratings are those values beyond which the device could be permanently damaged. Absolute maximum ratings are stress ratings only and functional device operation is not implied.

■ ELECTRICAL CHARACTERISTICS ($T_A=25^\circ\text{C}$, unless otherwise specified)

PARAMETER	SYMBOL	TEST CONDITIONS	MIN	TYP	MAX	UNIT
Collector-Emitter Breakdown Voltage	$V_{(BR)CEO}$	$I_C=50\text{mA}$, $I_B=0$	120			V
Collector Cut-off Current	I_{CBO}	$V_{CB}=120\text{V}$, $I_E=0$			10	μA
Emitter Cut-off Current	I_{EBO}	$V_{EB}=5\text{V}$, $I_C=0$			10	μA
DC Current Gain	h_{FE}	$V_{CE}=5\text{V}$, $I_C=1\text{A}$	55		160	
Collector-Emitter Saturation Voltage	$V_{CE(sat)}$	$I_C=6\text{A}$, $I_B=0.6\text{A}$			2.0	V
Base-Emitter Voltage	V_{BE}	$V_{CE}=5\text{V}$, $I_C=5\text{A}$			1.5	V
Transition Frequency	f_T	$V_{CE}=5\text{V}$, $I_C=1\text{A}$		12		MHz
Collector Output Capacitance	C_{ob}	$V_{CB}=10\text{V}$, $I_E=0$, $f=1\text{MHz}$		170		pF

■ CLASSIFICATION OF h_{FE}

RANK	R	O
RANGE	55 ~ 110	80 ~ 160

TYPICAL CHARACTERISTICS

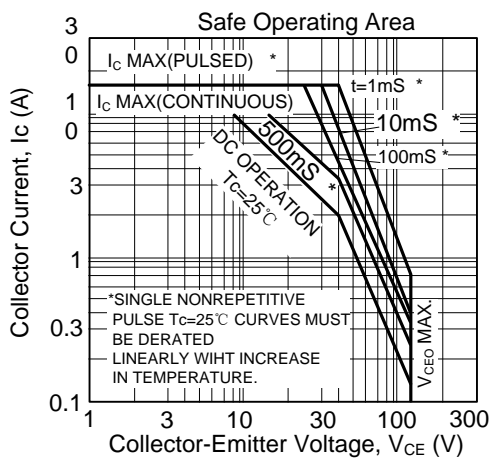
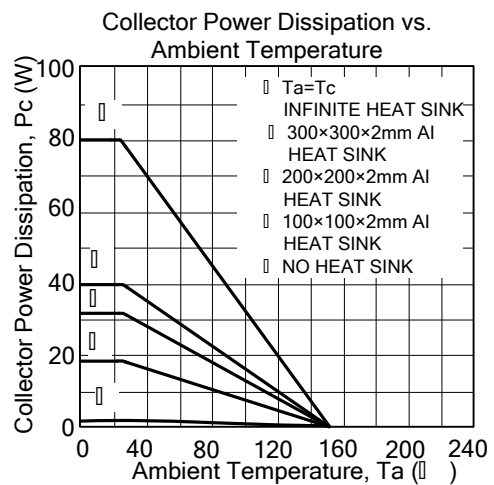
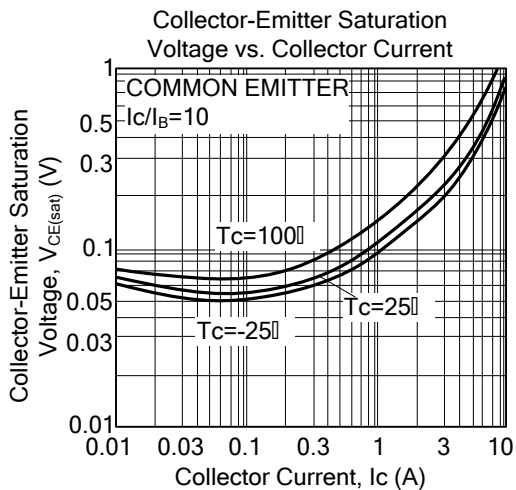
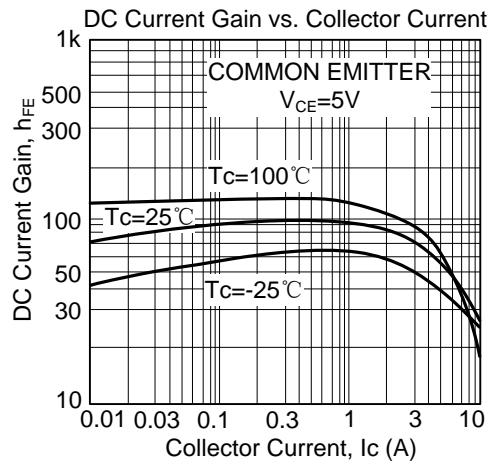
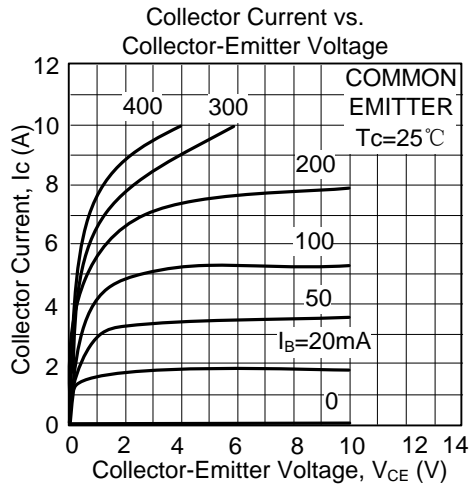

UTC assumes no responsibility for equipment failures that result from using products at values that exceed, even momentarily, rated values (such as maximum ratings, operating condition ranges, or other parameters) listed in products specifications of any and all UTC products described or contained herein. UTC products are not designed for use in life support appliances, devices or systems where malfunction of these products can be reasonably expected to result in personal injury. Reproduction in whole or in part is prohibited without the prior written consent of the copyright owner. UTC reserves the right to make changes to information published in this document, including without limitation specifications and product descriptions, at any time and without notice. This document supersedes and replaces all information supplied prior to the publication hereof.