



# 2SA1201

## PNP SILICON TRANSISTOR

### SILICON PNP EPITAXIAL TRANSISTOR

■ DESCRIPTION

The UTC **2SA1201** is designed for power amplifier and voltage amplifier applications.

■ FEATURES

- \*High voltage:  $V_{CE0} = -120V$
- \*High transition frequency:  $f_T = 120MHz$ (typ.)
- \* $P_c = 1$  to  $2$  W(mounted on ceramic substrate)

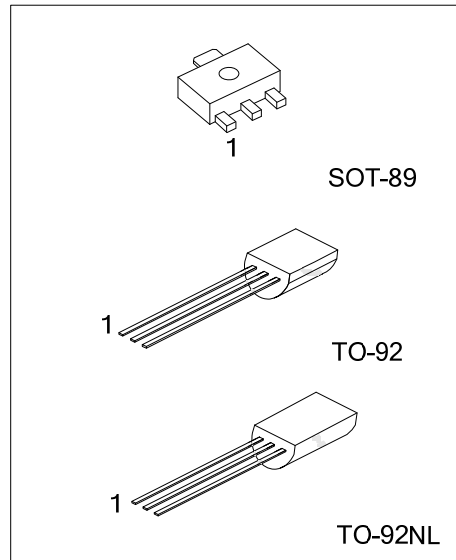

■ ORDERING INFORMATION

Ordering Number		Package	Pin Assignment			Packing
Lead Free	Halogen Free		1	2	3	
2SA1201L-x-AB3-R	2SA1201G-x-AB3-R	SOT-89	B	C	E	Tape Reel
2SA1201L-x-T92-B	2SA1201G-x-T92-B	TO-92	E	C	B	Tape Box
2SA1201L-x-T92-K	2SA1201G-x-T92-K	TO-92	E	C	B	Bulk
2SA1201L-x-T9N-B	2SA1201G-x-T9N-B	TO-92NL	E	C	B	Tape Box
2SA1201L-x-T9N-K	2SA1201G-x-T9N-K	TO-92NL	E	C	B	Bulk

Note: Pin Assignment: B: Base C: Collector E: Emitter

<p>2SA1201G-x-AB3-R</p>	<p>(1) R: Tape Reel, B: Tape Box, K: Bulk</p> <p>(2) AB3: SOT-89, T92: TO-92, T9N: TO-92NL</p> <p>(3) x: refer to Classification of <math>h_{FE}</math></p> <p>(4) G: Halogen Free and Lead Free, L: Lead Free</p>
-------------------------	--

■ MARKING

SOT-89	TO-92	TO-92NL

■ ABSOLUTE MAXIMUM RATINGS ( $T_A=25^\circ\text{C}$ , unless otherwise specified)

PARAMETER		SYMBOL	RATINGS	UNIT
Collector-Base Voltage		$V_{CBO}$	-120	V
Collector-Emitter Voltage		$V_{CEO}$	-120	V
Emitter-Base Voltage		$V_{EBO}$	-5	V
Collector Current		$I_C$	-800	mA
Base Current		$I_B$	-160	mA
Collector Power Dissipation	SOT-89	$P_C$	500	mW
	TO-92/TO-92NL		1000 (Note 2)	mW
			600	mW
Junction Temperature		$T_J$	150	$^\circ\text{C}$
Storage Temperature		$T_{STG}$	-55 ~ +150	$^\circ\text{C}$

Notes: 1. Absolute maximum ratings are those values beyond which the device could be permanently damaged.

Absolute maximum ratings are stress ratings only and functional device operation is not implied.

2. Mounted on cermic substrate(  $250\text{mm}^2 \times 0.8\text{t}$  )

■ ELECTRICAL CHARACTERISTICS ( $T_A=25^\circ\text{C}$ , unless otherwise specified)

PARAMETER	SYMBOL	TEST CONDITIONS	MIN	TYP	MAX	UNIT
Collector to Emitter Breakdown Voltage	$V_{(BR)CEO}$	$I_C = -10\text{mA}, I_B = 0$	-120			V
Emitter to Base Breakdown Voltage	$V_{(BR)EBO}$	$I_E = -1\text{mA}, I_C = 0$	-5			V
Collector Cut-Off Current	$I_{CBO}$	$V_{CB} = -120\text{V}, I_E = 0$			-0.1	$\mu\text{A}$
Emitter Cut-Off Current	$I_{EBO}$	$V_{EB} = -5\text{V}, I_C = 0$			-0.1	$\mu\text{A}$
DC Current Gain	$h_{FE}$	$V_{CE} = -5\text{V}, I_C = -100\text{mA}$	80		240	
Collector to Emitter Saturation Voltage	$V_{CE(SAT)}$	$I_C = -500\text{mA}, I_B = -50\text{mA}$			-1.0	V
Base to Emitter Voltage	$V_{BE}$	$V_{CE} = -5\text{V}, I_C = -100\text{mA}$			-1.0	V
Transition Frequency	$f_T$	$V_{CE} = -5\text{V}, I_C = -100\text{mA}$		120		MHz
Collector Output Capacitance	$C_{OB}$	$V_{CB} = -10\text{V}, I_E = 0, f = 1\text{MHz}$			30	pF

■ CLASSIFICATION OF  $h_{FE}$

RANK	O	Y
RANGE	80 - 160	120 - 240

## TYPICAL CHARACTERISTICS

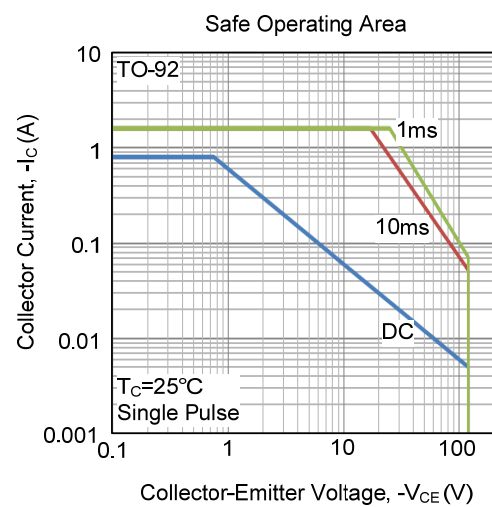
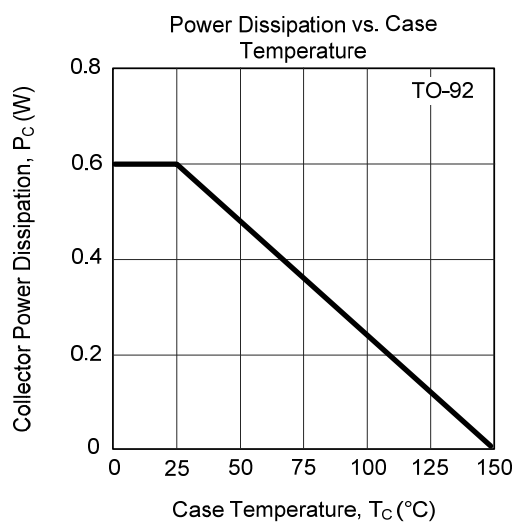
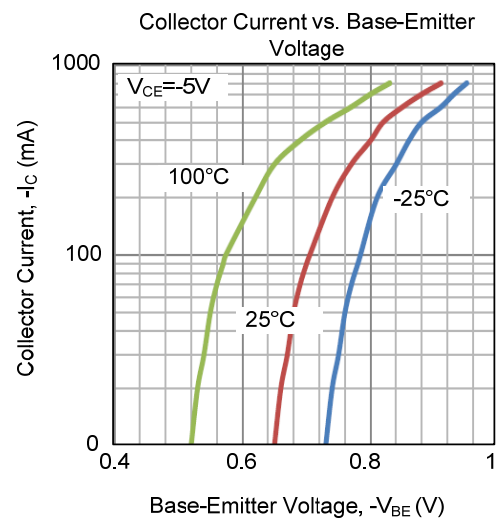
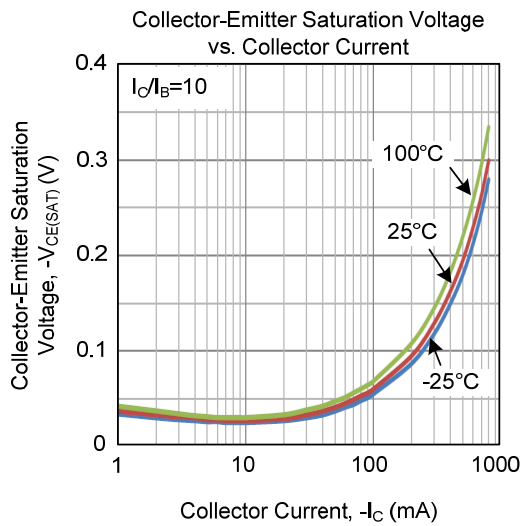
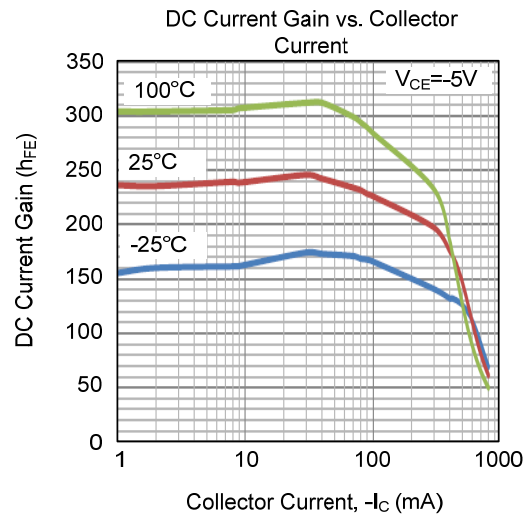
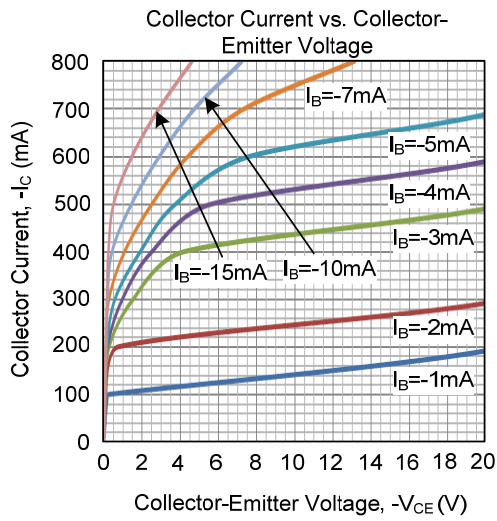

UTC assumes no responsibility for equipment failures that result from using products at values that exceed, even momentarily, rated values (such as maximum ratings, operating condition ranges, or other parameters) listed in products specifications of any and all UTC products described or contained herein. UTC products are not designed for use in life support appliances, devices or systems where malfunction of these products can be reasonably expected to result in personal injury. Reproduction in whole or in part is prohibited without the prior written consent of the copyright owner. UTC reserves the right to make changes to information published in this document, including without limitation specifications and product descriptions, at any time and without notice. This document supersedes and replaces all information supplied prior to the publication hereof.