



2SC2482

NPN EPITAXIAL SILICON TRANSISTOR

NPN EPITAXIAL PLANAR TRANSISTOR

■ FEATURES

- * High Voltage : $V_{(BR)CEO} = 300V$
- * Small Collector Output Capacitance: $C_{ob} = 3.0pF(Typ.)$

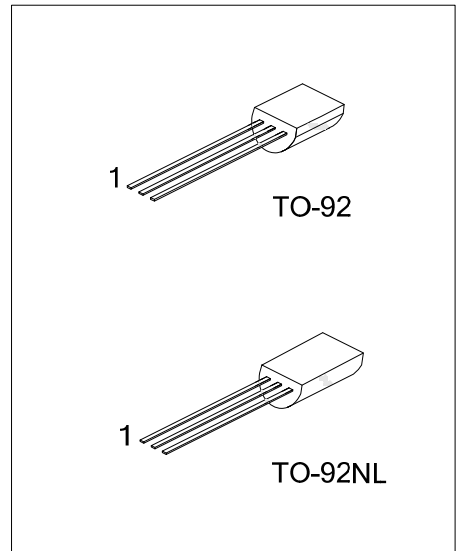

■ ORDERING INFORMATION

Ordering Number		Package	Pin Assignment			Packing
Lead Free	Halogen Free		1	2	3	
2SC2482L-T92-B	2SC2482G-T92-B	TO-92	E	C	B	Tape Box
2SC2482L-T92-K	2SC2482G-T92-K	TO-92	E	C	B	Bulk
2SC2482L-T9N-B	2SC2482G-T9N-B	TO-92NL	E	C	B	Tape Box
2SC2482L-T9N-K	2SC2482G-T9N-K	TO-92NL	E	C	B	Bulk

Note: Pin Assignment: E: Emitter C: Collector B: Base

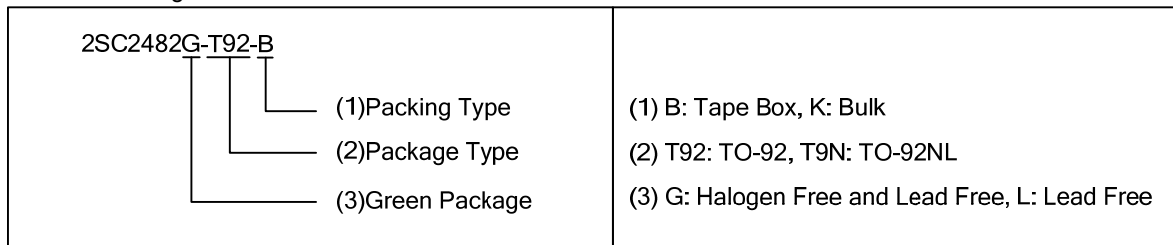

■ MARKING

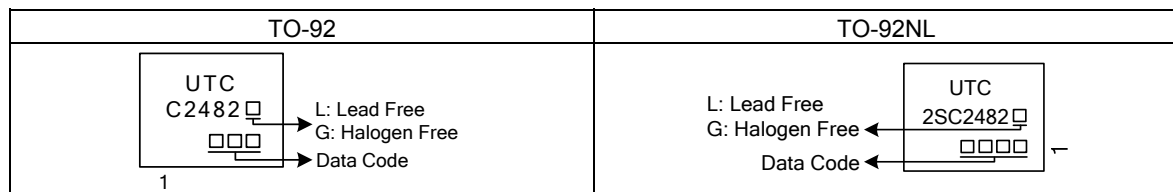

■ ABSOLUTE MAXIMUM RATING ($T_A=25^\circ\text{C}$, unless otherwise specified)

PARAMETER	SYMBOL	RATINGS	UNIT
Collector-Base Voltage	V_{CBO}	300	V
Collector-Emitter Voltage	V_{CEO}	300	V
Emitter-Base Voltage	V_{EBO}	7	V
Collector Current	I_C	100	mA
Base Current	I_B	50	mA
Collector Power Dissipation	P_C	900	mW
Junction Temperature	T_J	+150	$^\circ\text{C}$
Storage Temperature	T_{STG}	-55 ~ +150	$^\circ\text{C}$

Notes: 1. Absolute maximum ratings are those values beyond which the device could be permanently damaged.
Absolute maximum ratings are stress ratings only and functional device operation is not implied.

■ ELECTRICAL CHARACTERISTICS ($T_A=25^\circ\text{C}$, unless otherwise specified)

PARAMETER	SYMBOL	TEST CONDITIONS	MIN	TYP	MAX	UNIT
Collector Cut-Off Current	I_{CBO}	$V_{CB}=240\text{V}$, $I_E=0$			1.0	μA
Emitter Cut-Off Current	I_{EBO}	$V_{EB}=7\text{V}$, $I_C=0$			1.0	μA
DC Current Gain	$h_{FE(1)}$	$V_{CE}=10\text{V}$, $I_C=4\text{mA}$	20			
	$h_{FE(2)}$	$V_{CE}=10\text{V}$, $I_C=20\text{mA}$	30		150	
Collector-Emitter Saturation Voltage	$V_{CE(sat)}$	$I_C=10\text{mA}$, $I_B=1\text{mA}$			1.0	V
Base- Emitter Saturation Voltage	$V_{BE(sat)}$	$I_C=10\text{mA}$, $I_B=1\text{mA}$			1.0	V
Transition Frequency	f_T	$V_{CE}=10\text{V}$, $I_C=20\text{mA}$	50			MHz
Collector Output Capacitance	C_{ob}	$V_{CB}=20\text{V}$, $I_E=0$, $f=1\text{MHz}$		3.0		pF

■ TYPICAL CHARACTERISTICS

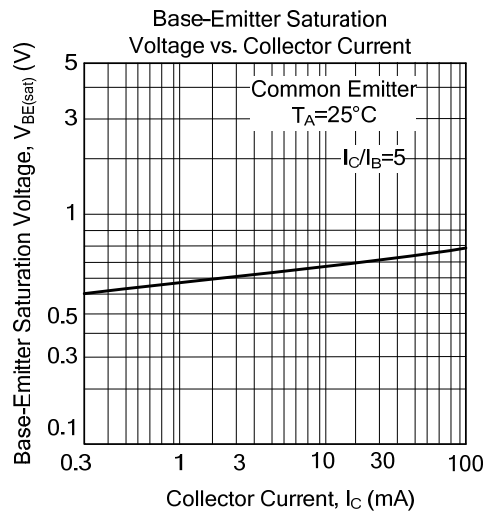
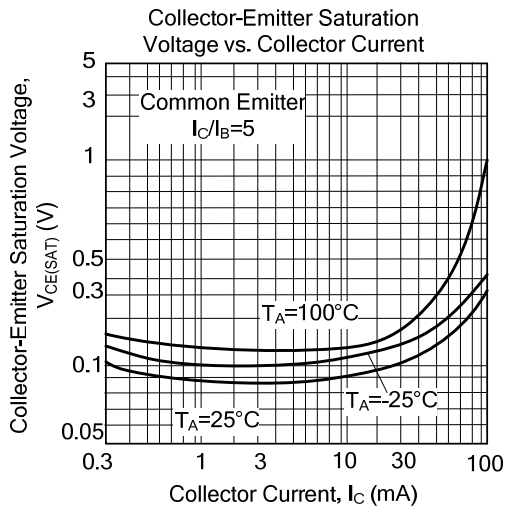
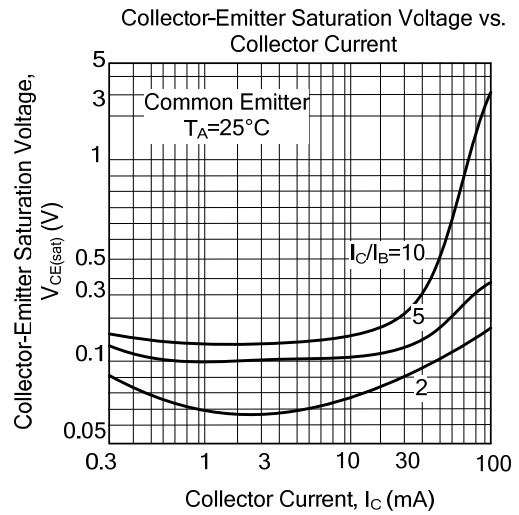
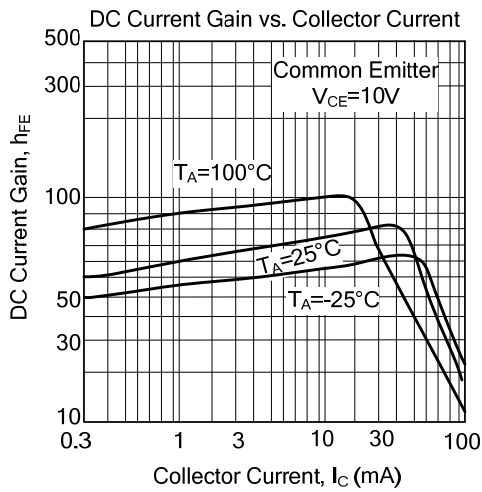
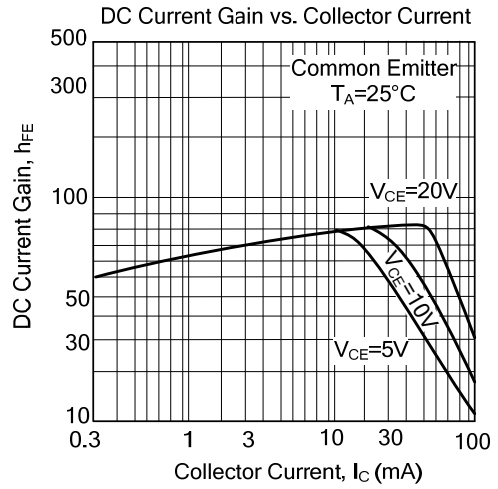
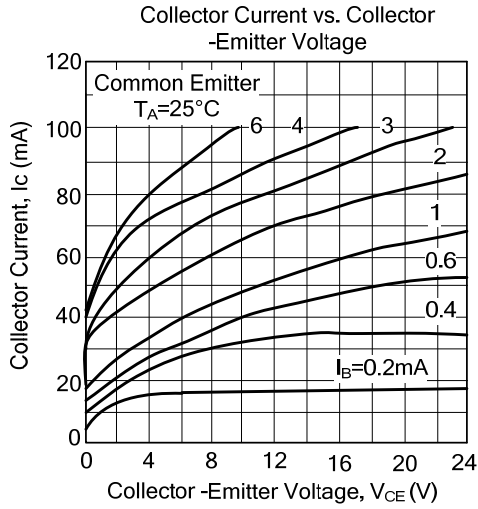

■ TYPICAL CHARACTERISTICS (Cont.)

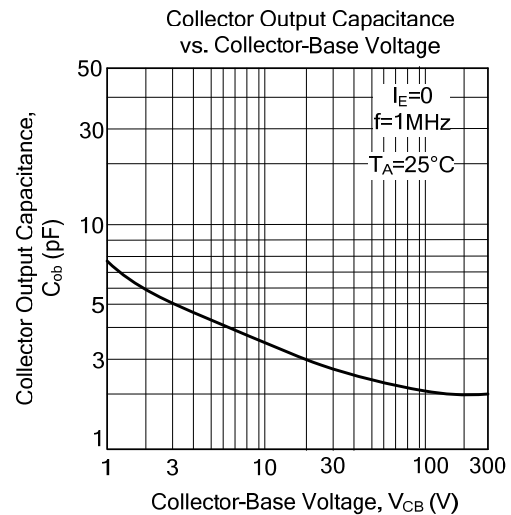
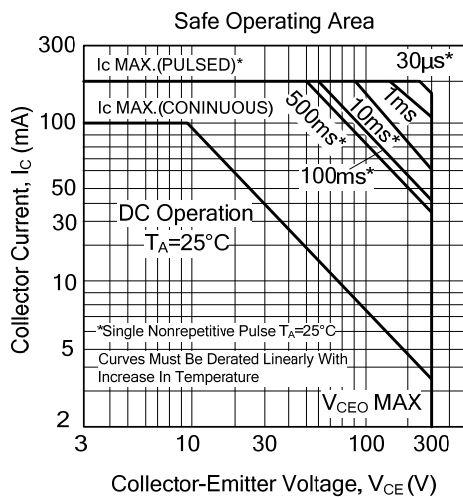
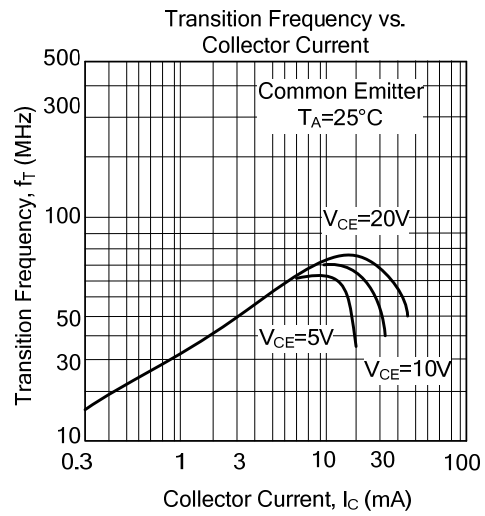
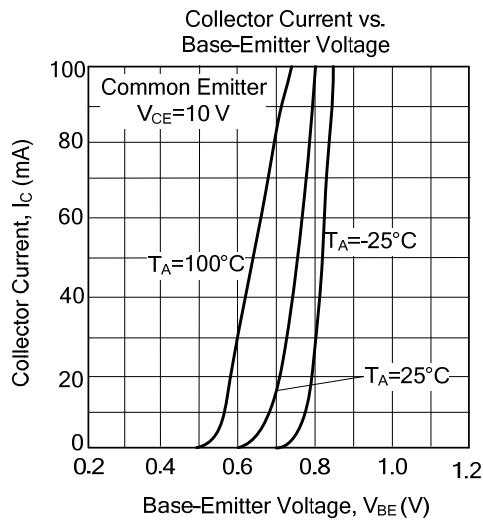

UTC assumes no responsibility for equipment failures that result from using products at values that exceed, even momentarily, rated values (such as maximum ratings, operating condition ranges, or other parameters) listed in products specifications of any and all UTC products described or contained herein. UTC products are not designed for use in life support appliances, devices or systems where malfunction of these products can be reasonably expected to result in personal injury. Reproduction in whole or in part is prohibited without the prior written consent of the copyright owner. The information presented in this document does not form part of any quotation or contract, is believed to be accurate and reliable and may be changed without notice.