



UP9T15G

Power MOSFET

N-CHANNEL ENHANCEMENT MODE POWER MOSFET

DESCRIPTION

The **UP9T15G** uses advanced trench technology to provide excellent $R_{DS(ON)}$, low gate charge and operation with low gate voltages. This device is suitable for use as a load switch or in PWM applications.

FEATURES

- * $V_{DS}(V)=20V$
- * $I_D=12.5A$ ($V_{GS}=4.5V$)
- * $R_{DS(ON)} < 50m\Omega$ @ $V_{GS} = 4.5 V$, $I_D = 6 A$
- * $R_{DS(ON)} < 80m\Omega$ @ $V_{GS} = 2.5 V$, $I_D = 5.2 A$

SYMBOL

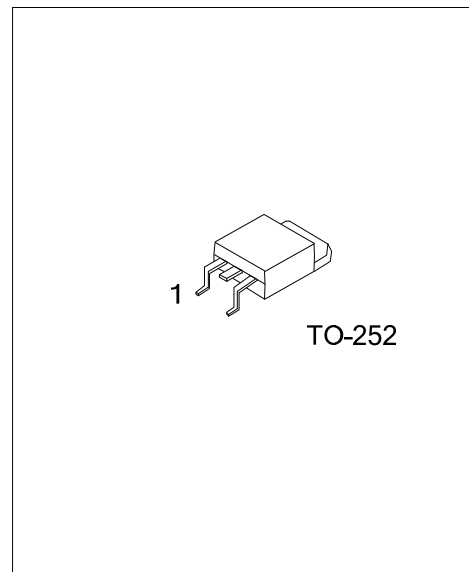
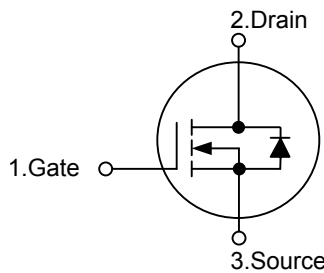

ORDERING INFORMATION

Ordering Number		Package	Pin Assignment			Packing
Lead Free	Halogen Free		1	2	3	
UP9T15GL-TN3-R	UP9T15GP-TN3-R	TO-252	G	D	S	Tape Reel

Note: Pin Assignment: G: Gate D: Drain S: Source

<p>UP9T15GL-TN3-R</p> <p>(1) Packing Type</p> <p>(2) Package Type</p> <p>(3) Green Package</p>	<p>(1) R: Tape Reel</p> <p>(2) TN3: TO-252</p> <p>(3) L: Lead Free, P: Halogen Free and Lead Free</p>
--	---

MARKING

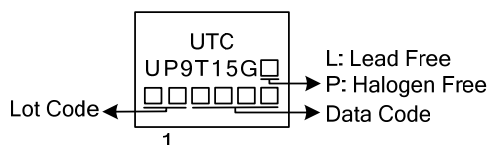

■ ABSOLUTE MAXIMUM RATINGS ($T_J = 25^\circ\text{C}$, unless otherwise noted)

PARAMETER	SYMBOL	RATINGS	UNIT
Drain-Source Voltage	V_{DS}	20	V
Gate-Source Voltage	V_{GS}	± 12	V
Continuous Drain Current, @ $V_{GS} = 4.5\text{V}$	I_D	12.5	A
Pulsed Drain Current	I_{DM}	60	A
Power Dissipation	P_D	12.5	W
Linear Derating Factor		0.1	W/ $^\circ\text{C}$
Junction Temperature	T_J	+150	$^\circ\text{C}$
Strong Temperature	T_{STG}	-55 ~ +150	$^\circ\text{C}$

Note: Absolute maximum ratings are those values beyond which the device could be permanently damaged.

Absolute maximum ratings are stress ratings only and functional device operation is not implied.

■ THERMAL DATA

PARAMETER	SYMBOL	MIN	TYP	MAX	UNIT
Junction-to-Ambient	θ_{JA}			110	$^\circ\text{C}/\text{W}$
Junction-to-Case	θ_{JC}			10	$^\circ\text{C}/\text{W}$

■ ELECTRICAL CHARACTERISTICS ($T_J = 25^\circ\text{C}$, unless otherwise noted)

PARAMETER	SYMBOL	TEST CONDITIONS	MIN	TYP	MAX	UNIT
OFF CHARACTERISTICS						
Drain-Source Breakdown Voltage	BV_{DSS}	$V_{GS} = 0\text{ V}, I_D = 250\ \mu\text{A}$	20			V
Drain-Source Leakage Current	I_{DSS}	$V_{DS} = 20\text{ V}, V_{GS} = 0\text{ V}$			1	μA
Gate-Body Leakage Current	I_{GSS}	$V_{GS} = \pm 12\text{ V}$			± 100	nA
Breakdown Voltage Temperature Coefficient	$\Delta BV_{DSS}/\Delta T_J$	$25^\circ\text{C}, I_D = 1\text{mA}$		0.02		V/ $^\circ\text{C}$
ON CHARACTERISTICS						
Gate Threshold Voltage	$V_{GS(TH)}$	$V_{DS} = V_{GS}, I_D = 250\ \mu\text{A}$	0.5		1.5	V
Static Drain-Source On-Resistance	$R_{DS(ON)}$	$V_{GS} = 4.5\text{ V}, I_D = 6\text{ A}$			50	m Ω
		$V_{GS} = 2.5\text{ V}, I_D = 5.2\text{ A}$			80	
DYNAMIC PARAMETERS						
Input Capacitance	C_{ISS}	$V_{DS} = 20\text{ V}, V_{GS} = 0\text{ V},$ $f = 1.0\text{MHz}$		360	580	pF
Output Capacitance	C_{OSS}			70		
Reverse Transfer Capacitance	C_{RSS}			50		
SWITCHING PARAMETERS						
Total Gate Charge(Note2)	Q_G	$V_{DS} = 16\text{ V}, V_{GS} = 4.5\text{ V}, I_D = 10\text{ A}$		5	8	nC
Gate Source Charge	Q_{GS}			1		
Gate Drain Charge	Q_{GD}			2		
Turn-ON Delay Time(Note2)	$t_{D(ON)}$	$V_{GS} = 5\text{ V}, V_{DS} = 10\text{V}, R_D = 1\ \Omega,$ $I_D = 10\text{ A}, R_G = 3.3\ \Omega$		8		ns
Turn-ON Rise Time	t_R			55		
Turn-OFF Delay Time	$t_{D(OFF)}$			10		
Turn-OFF Fall-Time	t_F			3		
SOURCE- DRAIN DIODE RATINGS AND CHARACTERISTICS						
Forward On Voltage(Note2)	V_{SD}	$I_S = 10\text{ A}, V_{GS} = 0\text{V}$			1.3	V
Reverse Recovery Time(Note2)	t_{RR}	$I_S = 10\text{ A}, V_{GS} = 0\text{ V}, di/dt = 100$		17		ns
Reverse Recovery Charge	Q_{RR}	A/ μs		9		nC

Notes: 1. Pulse width limited by safe operating area.

2. Pulse width $\leq 300\ \mu\text{s}$, duty cycle $\leq 2\%$.

TYPICAL CHARACTERISTICS

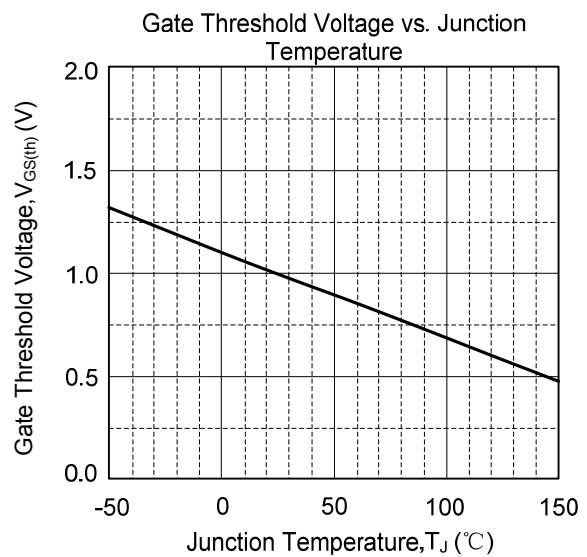
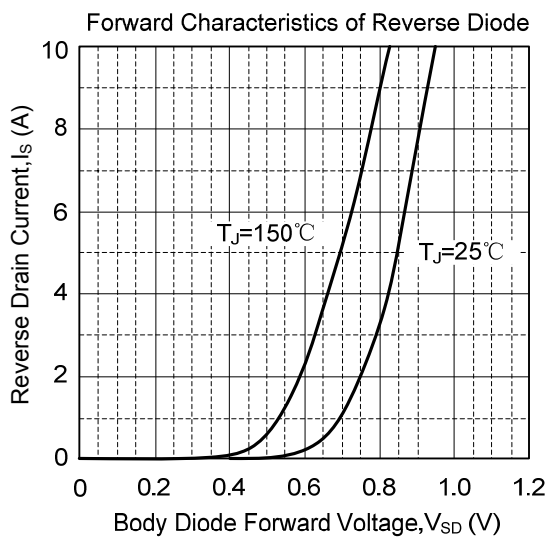
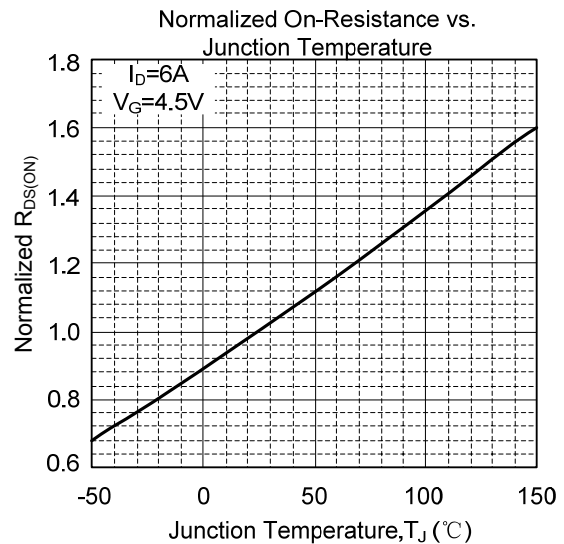
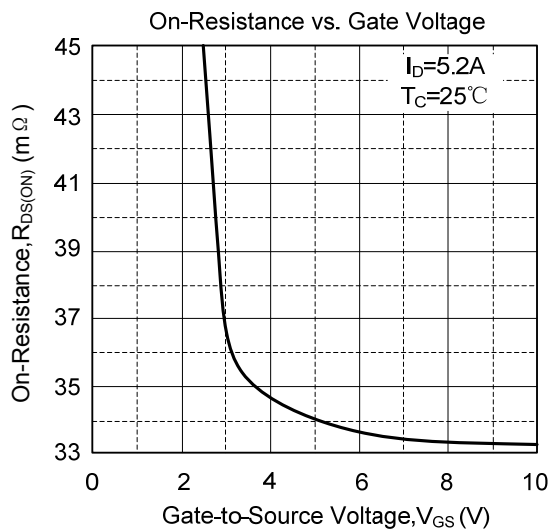
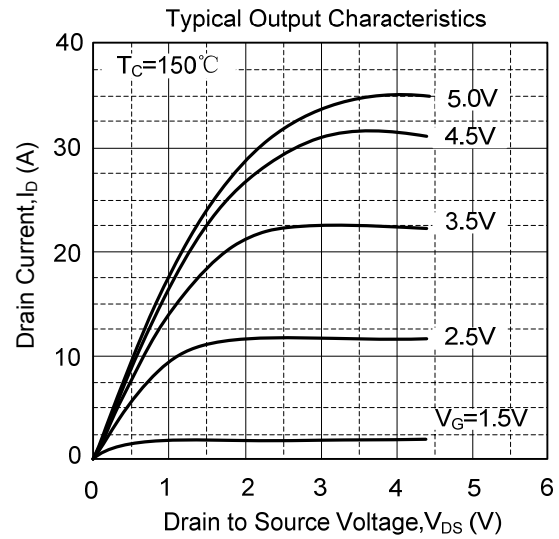
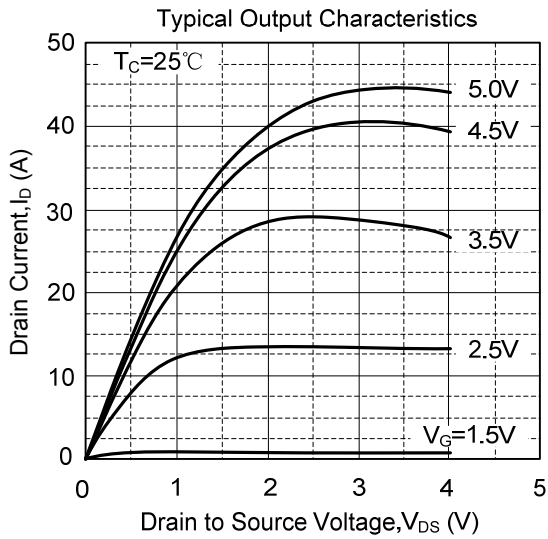

TYPICAL CHARACTERISTICS(Cont.)

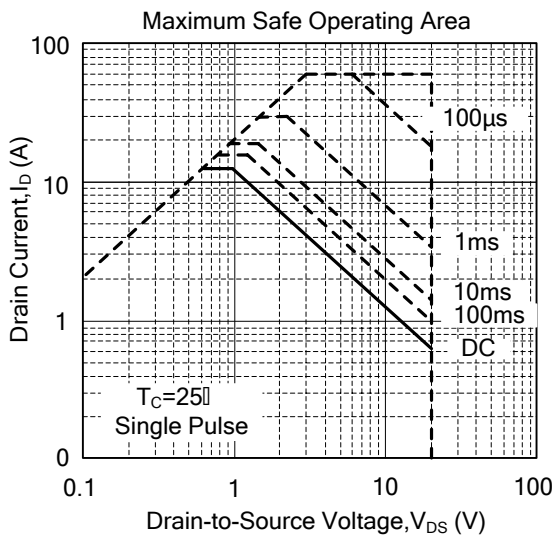
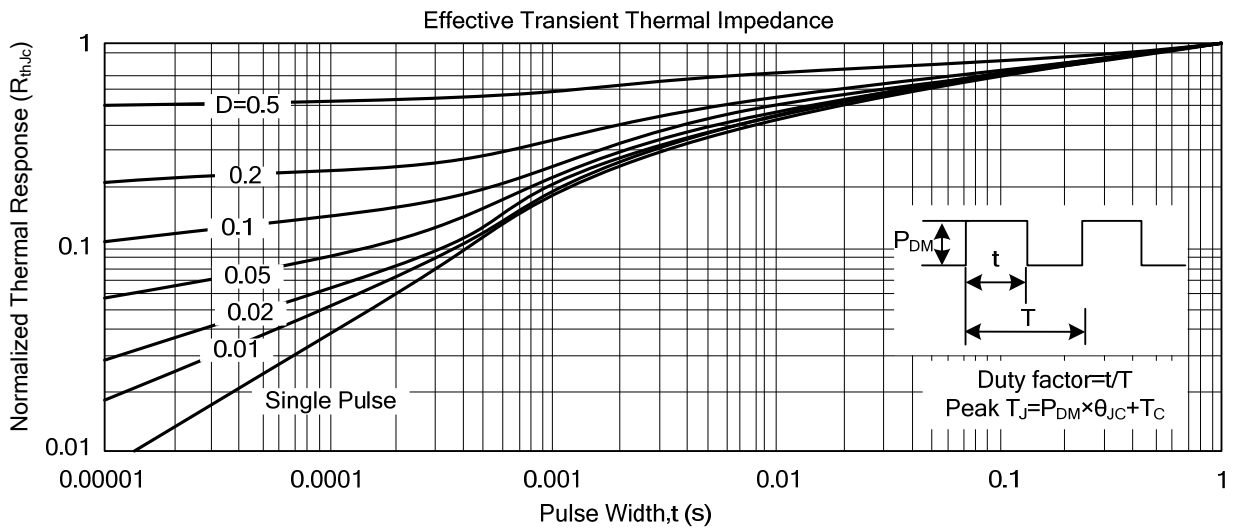
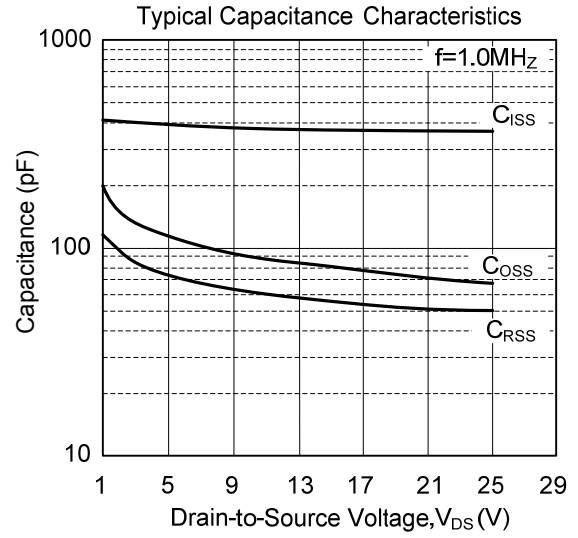
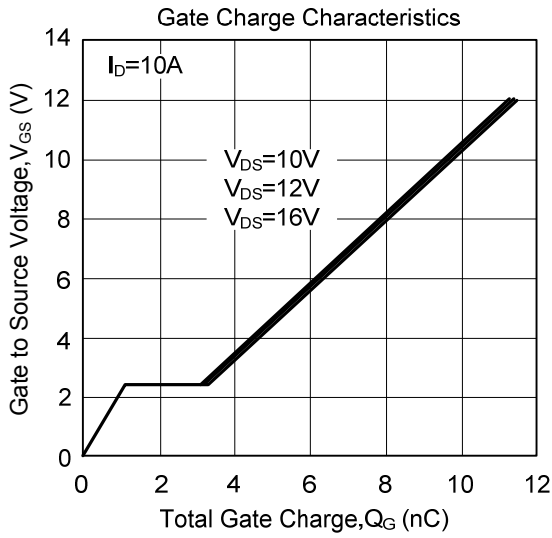

UTC assumes no responsibility for equipment failures that result from using products at values that exceed, even momentarily, rated values (such as maximum ratings, operating condition ranges, or other parameters) listed in products specifications of any and all UTC products described or contained herein. UTC products are not designed for use in life support appliances, devices or systems where malfunction of these products can be reasonably expected to result in personal injury. Reproduction in whole or in part is prohibited without the prior written consent of the copyright owner. The information presented in this document does not form part of any quotation or contract, is believed to be accurate and reliable and may be changed without notice.