



SFR1020C

DIODE

ULTRA-FAST RECOVERY RECTIFIER DIODES

DESCRIPTION

UTC **SFR1020C** is dual center tap rectifier suited for high frequency Switching Mode PowerSupplies applications.

FEATURES

- * High Surge Current Capability
- * Suited For Smpls, DC ~ DC Converters
- * Low Forward And Reverse Recovery Time
- * Low Losses

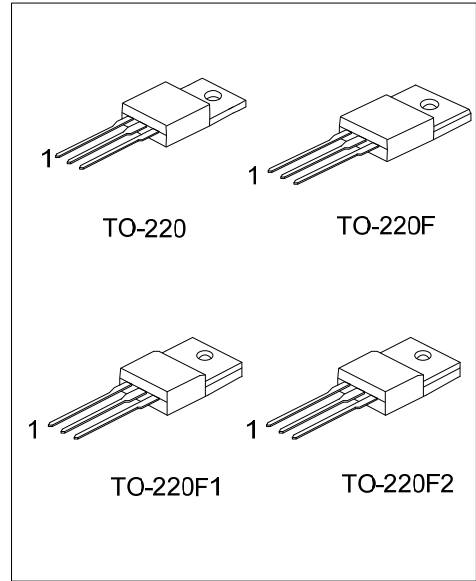

CONNECTION DIAGRAM

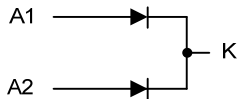

ORDERING INFORMATION

Order Number		Package	Pin Assignment			Packing
Lead Free	Halogen Free		1	2	3	
SFR1020CL-TA3-T	SFR1020CG-TA3-T	TO-220	A1	K	A2	Tube
SFR1020CL-TF1-T	SFR1020CG-TF1-T	TO-220F1	A1	K	A2	Tube
SFR1020CL-TF2-T	SFR1020CG-TF2-T	TO-220F2	A1	K	A2	Tube
SFR1020CL-TF3-T	SFR1020CG-TF3-T	TO-220F	A1	K	A2	Tube

Note: Pin Assignment: A: Anode K: Cathode

<p>SFR1020CG-TA3-T</p>	<p>(1) T: Tube (2) TA3: TO-220, TF2: TO-220F2, TF1: TO-220F1, TF3: TO-220F (3) G: Halogen Free and Lead Free, L: Lead Free</p>
------------------------	--

MARKING

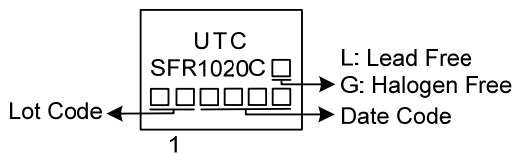

■ ABSOLUTE MAXIMUM RATING (limiting values, per leg)

PARAMETER	SYMBOL	RATINGS	UNIT
Repetitive Peak Reverse Voltage	V_{RRM}	200	V
RMS Forward Current(Total)	$I_{F(RMS)}$	10	A
Average Forward Current $\delta=0.5$ $T_C=125^\circ\text{C}$ (Per leg)	$I_{F(AV)}$	5	A
Surge Non Repetitive Forward Current, $t_p=10\text{ms}$ Sinusoidal	I_{FSM}	50	A
Storage temperature range	T_{STG}	-60 ~ +150	$^\circ\text{C}$

Notes: 1. Absolute maximum ratings are those values beyond which the device could be permanently damaged. Absolute maximum ratings are stress ratings only and functional device operation is not implied.

2. The device is guaranteed to meet performance specification within $0^\circ\text{C} \sim +70^\circ\text{C}$ operating temperature range and assured by design from $-20^\circ\text{C} \sim +85^\circ\text{C}$.

■ ELECTRICAL CHARACTERISTICS (per leg)

PARAMETER	SYMBOL	TEST CONDITIONS	MIN	TYP	MAX	UNIT
Reverse Leakage Current (Note1)	I_R	$V_R=V_{RRM}, T_J=25^\circ\text{C}$			50	μA
		$V_R=V_{RRM}, T_J=100^\circ\text{C}$			0.6	mA
Forward Voltage Drop (Note2)	V_F	$I_F=5.0\text{A}, T_J=25^\circ\text{C}$			1.1	V
		$I_F=5.0\text{A}, T_J=125^\circ\text{C}$		0.82	1.0	V

Notes: 1. $t_p = 5 \text{ ms}$, $\delta < 2 \%$.

2. $t_p = 380 \mu\text{s}$, $\delta < 2 \%$.

To evaluate the conduction losses use the following equation: $P = 0.78 \times I_{F(AV)} + 0.042 \times I_F^2$ (RMS).

■ RECOVERY CHARACTERISTICS

PARAMETER	SYMBOL	TEST CONDITIONS	MIN	TYP	MAX	UNIT
Reverse Recovery Time	t_{rr}	$I_F=0.5\text{A}, dI_F/dt=50\text{A}/\mu\text{s}, V_R=30\text{V}$ $T_J=25^\circ\text{C}$			40	ns
Reverse Recovery Time	t_{rr}	$I_F=1\text{A}, dI_F/dt=50\text{A}/\mu\text{s}, V_R=30\text{V}$ $T_J=25^\circ\text{C}$		33		ns

Notes: 1. When diodes 1 and 2 are used simultaneously.

2. ΔT_J (diode 1) = $P(\text{diode 1}) \times R_{th(j-c)}$ (per leg) + $P(\text{diode 2}) \times R_{th(c)}$.

TYPICAL CHARACTERISTICS

Average Forward Power Dissipation Versus Average Forward Current (Per Diode)

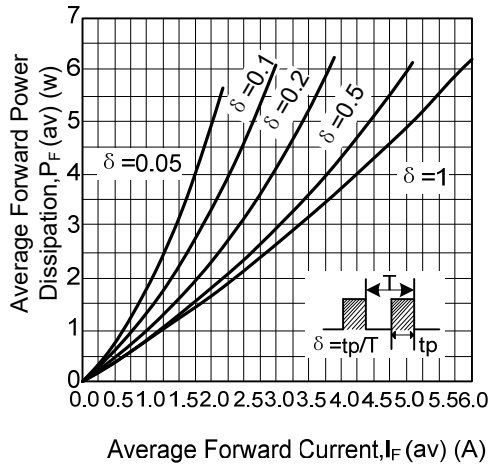

Peak Current Versus Form Factor (Per Diode)

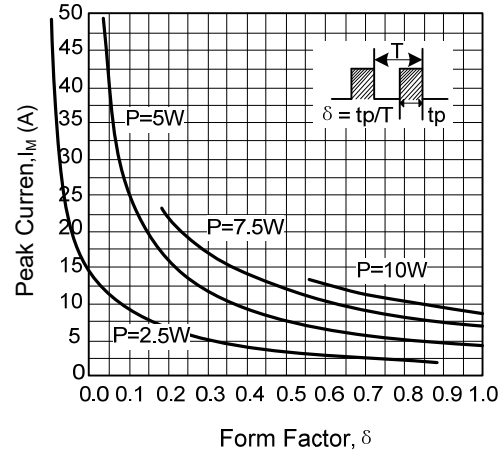

Average Forward Current Versus Ambient Temperature

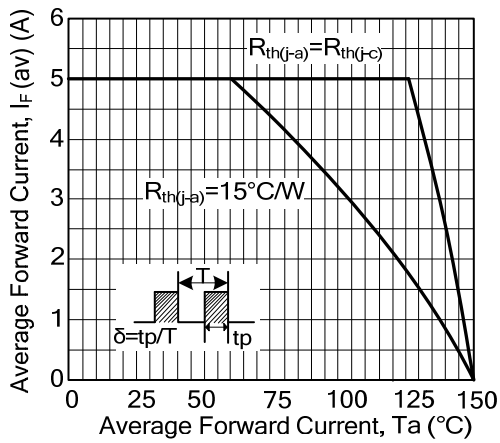

Non Repetitive Surge Peak Forward Current Versus Overload Duration

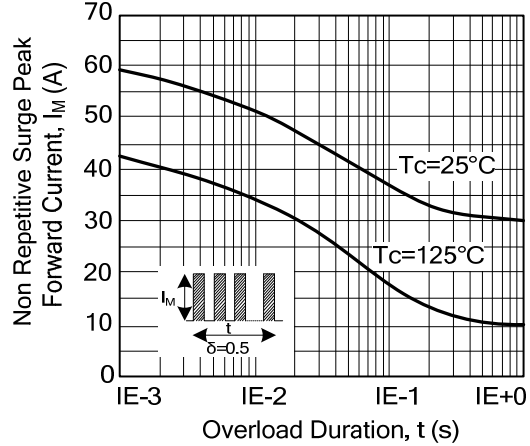

Forward Voltage Drop Versus Forward Current (Maximum Values, Per Diode)

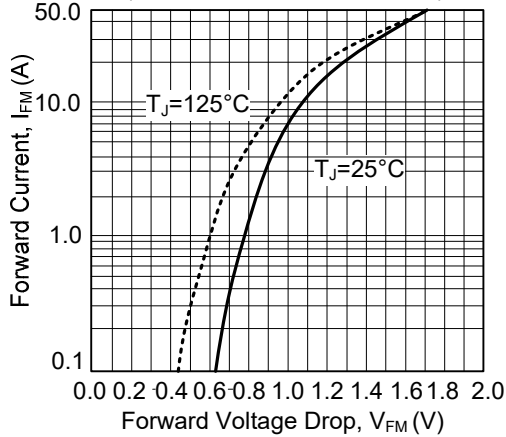

Relative Variation Of Thermal Versus Impedance Junction To Case Versus Pulse Duration

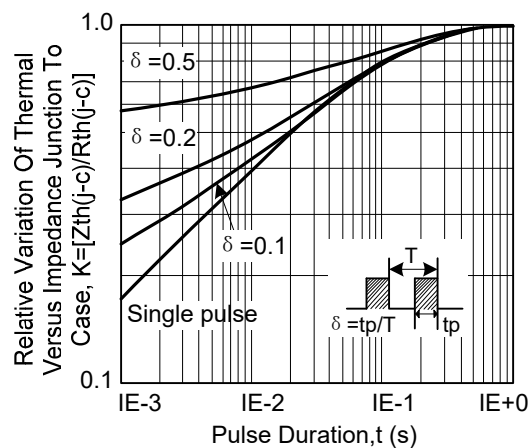

■ TYPICAL CHARACTERISTICS (Cont.)

Junction Capacitance Versus Reverse Voltage Applied (Typical Values, Per Diode)

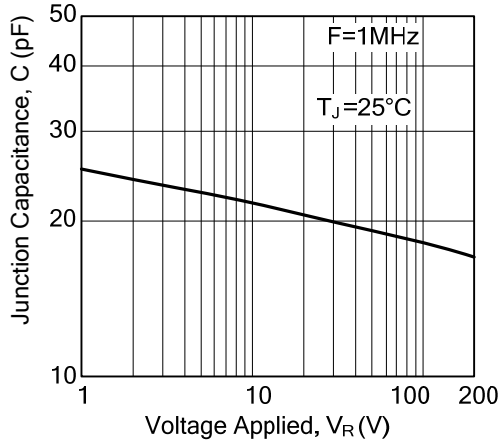

Reverse Recovery Charges Versus d_{IF}/D_t (Per Diode)

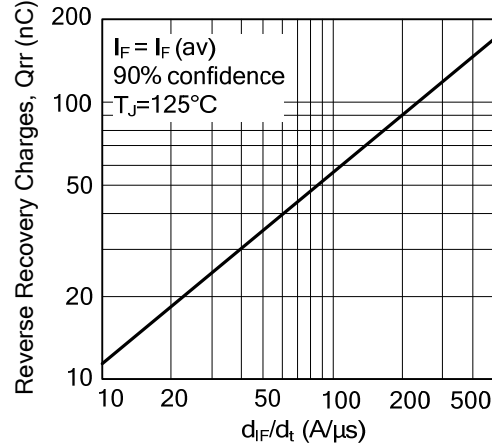

Peak Reverse Recovery Current Versus d_{IF}/D_t (Per Diode)

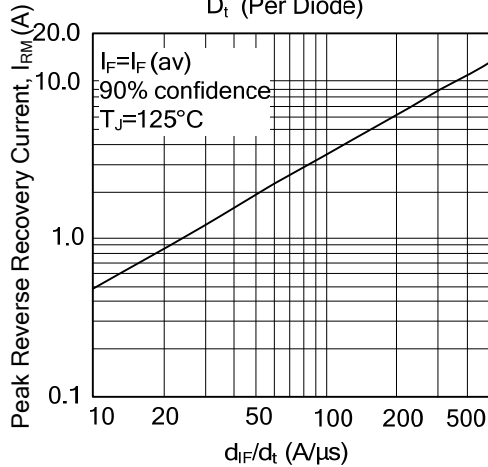

Dynamic Parameters Versus Junction Temperature (Per Diode)

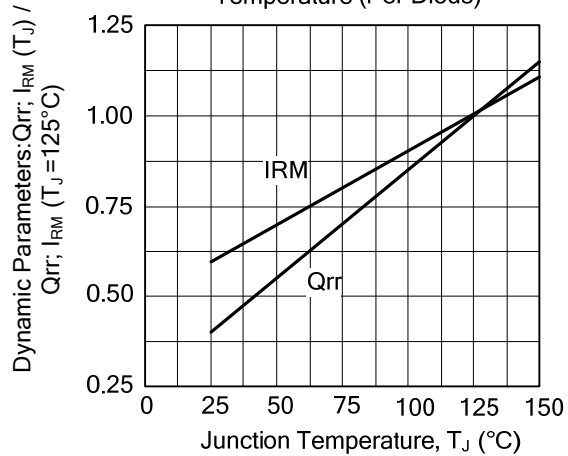

UTC assumes no responsibility for equipment failures that result from using products at values that exceed, even momentarily, rated values (such as maximum ratings, operating condition ranges, or other parameters) listed in products specifications of any and all UTC products described or contained herein. UTC products are not designed for use in life support appliances, devices or systems where malfunction of these products can be reasonably expected to result in personal injury. Reproduction in whole or in part is prohibited without the prior written consent of the copyright owner. UTC reserves the right to make changes to information published in this document, including without limitation specifications and product descriptions, at any time and without notice. This document supersedes and replaces all information supplied prior to the publication hereof.